

CARAN D'ACHE

Genève



Writing Instruments
& Accessories

CARAN^D'ACHE
Genève

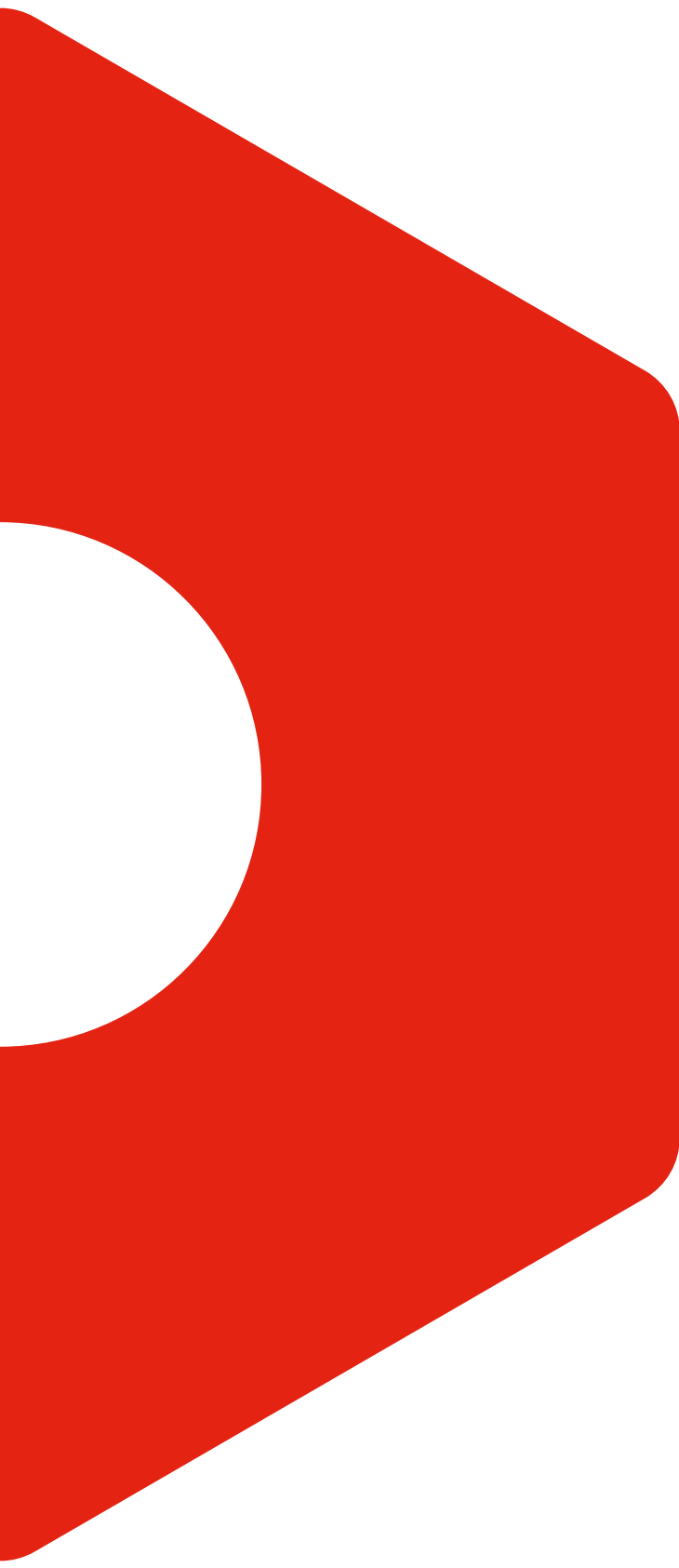

FROM AN ARTIST'S SIGNATURE TO THE ART OF BEAUTIFUL WRITING

In that area of emotions where Writing and images fuse together, the grace of a curving line, the energy in the stroke of a pen and the depth of a rich colour are among the elements that led Caran d'Ache to develop its passion for Fine Writing. Since 1915, steeped in the great traditions of Swiss Manufacturing, the company has created writing instruments, and a palette of colours, that are universally recognised as symbols of excellence.

These reliable, precise and precious objects have acquired an international reputation for combining creativity and distinction with the use of noble materials.

To continue this policy, our Geneva workshops carefully preserve their independent spirit and their commitment to authenticity and ethical production.

MANUFACTURED IN GENEVA WORKSHOPS

Caran d'Ache draws on a priceless heritage of technical expertise to preserve the art of handwriting. The company's writing instruments, globally recognised for their excellence, are entirely produced in Geneva. In the secret of their workshops, Caran d'Ache craftsmen boldly combine expertise and aesthetics in the great Swiss Made tradition. To create these emotive objects, which are also feats of technology, they offer original materials and perfect forms, giving writing an innate sense of refinement.

CARAN D'ACHE, IN LOVE WITH COLOUR

The play of light on the material... its soft, velvety texture... the precious pigments brought from mysterious places... There has been a genuine love of colours, and the traditions of manufacturing them, in our Geneva workshops ever since our first pencil was produced nearby in 1915. The fine, smooth leads, the subtly transparent watercolours and the brilliant, deep, light-resistant paints have been developed for creative professionals as well as amateur artists. They all reflect Caran d'Ache's exceptional Swiss Made quality and love of its craft. Caran d'Ache respects nature as well as people. The premium-quality cedar used in our pencils is certified FSC™, and our production of leads, pastels and paints carefully follows the principles of sustainable development.



THE ART OF BEAUTIFUL WRITING

Just as the art of Writing brings together characters, gestures and traditions, Caran d'Ache writing instruments represent refinement, creativity and expertise, all expressed with Swiss Made excellence.

For a century, Caran d'Ache collections have reflected the passion and the subtlety of Fine Writing. They are jewels of technology with inspired designs; emblems of excellence enhanced by rare and noble materials.

Lacquered, guilloched or polished bodies feel superb in the hand; rhodium-coated nibs or long-life tungsten ballpoints provide a great writing touch; contemporary or classic designs create a seductive visual appeal. Caran d'Ache writing instruments are treasures for all those who appreciate genuine distinction.



EXPERTISE

THE ARTISTIC CRAFTS

ENGRAVING

The fine engraving that characterises Caran d'Ache writing instruments is the product of patient, meticulous work. The company's innovative techniques of milling and engraving with lasers or diamonds make it possible to produce a large variety of outlines and reliefs that bring a design to life by creating a delicate play of light and shadow. Whether it is guillochage or personalised engraving, each piece receives the same attention to detail, making the finished instrument a treasure of refinement.

POLISHING

A soft touch, comfortable writing and perfect design... sometimes sparkling, sometimes matt, each part of these Caran d'Ache products is carefully worked. All the writing instruments finished in precious materials are polished, which is also a very important operation when applying lacquer or Chinese lacquer.

THE UNIQUE EXPERTISE OF THE LACQUER MASTER

A finish that requires exceptional precision, lacquer gloriously enhances a writing instrument with an incomparable brilliance and its large palette of tints that Caran d'Ache is constantly extending. Because preparing and applying lacquer requires such extraordinary skills, the work of the lacquer master is uniquely valuable. It demonstrates the company's commitment to authenticity and excellence in every product it creates.

JEWELLERY

Setting diamonds, rubies, sapphires, emeralds, and engraving initials, a name, or even a short message... Caran d'Ache offers all lovers of rare objects the possibility of personalising their writing instrument. If they wish, they can choose the precious stones, which will then be set by a Geneva jeweller. Each personalised writing instrument is numbered, engraved and accompanied by a certificate. Gemstones used by Caran d'Ache are from controlled, ethical sources, are not involved in the financing of armed conflicts and conform to United Nations resolutions.

NOBLE MATERIALS

PRECIOUS METALS: SILVER, RHODIUM, PLATINUM, PALLADIUM

Caran d'Ache creations in silver or solid gold are systematically controlled by the Federal Office of Metals and are certified with its seal. Gold is the metal used in the most beautiful work produced by Caran d'Ache craftsmen. Like real goldsmiths, they sculpt it, decorate it, engrave it and polish it.

But Caran d'Ache also explores other horizons with rhodium, the metal in the platinum family whose hardness and rarity make it twice as expensive as gold. Extremely strong, it enables writing instruments to keep their brilliance over the years, protecting them from corrosion and rust, as well as abrasion and tarnishing. Rare, pure and inert, rhodium is the most exclusive of the precious metals used by the company.

CHINESE LACQUER

A natural, living product derived from the sap of the Rhus Vernicifera tree, Chinese lacquer regularly inspires the most beautiful creations of the Maison Caran d'Ache. Using traditional expertise inherited from the great oriental masters, the company is one of the very few in the world to have the secret. The multiple coats of lacquer are applied over a period of twelve days. Chinese lacquer, which may be natural colour or tinted with pigments of blue, black or red, embellishes lighters and writing instruments in the Varius collections as well as the limited editions.





COLLECTIONS

VARIUS	13
LÉMAN & LÉMAN SLIM	33
ECRIDOR	63
LES CRAYONS DE LA MAISON	85

LIMITED EDITIONS

HOMMAGE	<i>Chinese Zodiac</i>	93
	<i>Spirit of Switzerland</i>	105
	<i>Oberalp</i>	109
SPECIAL	<i>Varius Peter Marino</i>	115
PRESTIGE	<i>1010 Timekeeper</i>	123
	<i>Caelograph</i>	129

WRITING ACCESSORIES

CHROMATICS	<i>Ink bottle</i>	137
	<i>Ink cartridges</i>	141
REFILLS		143

ACCESSORIES

LEATHER	<i>La Collection de la Maison</i>	147
	<i>La Collection Léman</i>	157
BELTS		165
CUFFLINKS		167

SERVICES

PERSONALISED ENGRAVING	170
FOUNTAIN PEN NIBS	171
INTERNATIONAL WARRANTY	172
CORPORATE GIFTS	173
PACKAGING	173
MERCHANDISING	174



COLLECTIONS





VARIUS

An accomplished form and hexagonal body with a unique feel... Caran d'Ache's iconic Varius collection is the result of our passionate work of materials. Chinese lacquer, carbon fibre, chain mail, ceramic and more recently genuine rubber and ebony wood echo the precious coating of this writing instrument. A rare conjunction of striking design and superb writing comfort, Varius is the only collection to offer fountain pen nibs in six widths, turning the art of handwriting into a daily pleasure.

- Four writing instruments:
 - Fountain pen, roller pen, ballpoint pen, mechanical pencil
 - Brass body finished in various materials
 - Articulated clip, using a spring mechanism
 - Silver, rhodium, gold-plated and rose gold-plated attributes
 - 18-carat gold nib available in seven distinct widths:
 - F, M, B and nibs EF, OM, OB, BB upon request
- Can be customised by means of personalised engraving
- International warranty
- Swiss Made

EBONY WOOD

Originating from the Asian and African rainforests, ebony is highly valued by artisans for its deep black colour and delicate feel. Caran d'Ache craftsmen magnify this noble wood with rose gold, revealing its subtle and precious grains.



THE CASE VARIUS

19.5 x 9.7 x 6.5 cm
Standard screen-printed case
Includes:
- the user guide / warranty
- two blue ink cartridges or one black Rollerball fine tip refill
or black M Goliath refill



VARIUS EBONY PINK-GOLD-PLATED FINISH

FOUNTAIN PEN / M-4490.142

Nib sizes: B -.152 / F -.132 / EF -.122 / OM -.112 / OB -.102
Nib: 18-carat gold, rose gold-plated
Cap: Screw
Piston ink pump or ink cartridge
Refill: Ink and cartridges Chromatics Collection (p.136-141)



VARIUS EBONY PINK-GOLD-PLATED FINISH

ROLLER PEN / 4470.142

Cap: Screw
Refills: Rollerball fine tip, Fineliner fine or medium tip blue or black (p.142)



VARIUS EBONY PINK-GOLD-PLATED FINISH

BALLPOINT PEN / 4480.142

Mechanism: Push button
Goliath refills: large, medium or fine (p.142)



VARIUS EBONY PINK-GOLD-PLATED FINISH

MECHANICAL PENCIL / 4460.142

0.7 mm lead
Mechanism: Push button
Refills: 0.7 mm graphite leads, HB or B and replacement erasers (p.143)



Caran d'Ache unveils a new version of the Varius Ebony, which this time boasts Rhodium Silver attributes. This model embodies the ultimate contrast between the sculptural beauty of Ebony wood and the sophisticated glow of silver metal. Entirely designed and realized in the Genevan workshops of Caran d'Ache, the Varius Ebony range is available in fountain pens with seven different pen widths, roller pens, ballpoint pens and pencil holders.

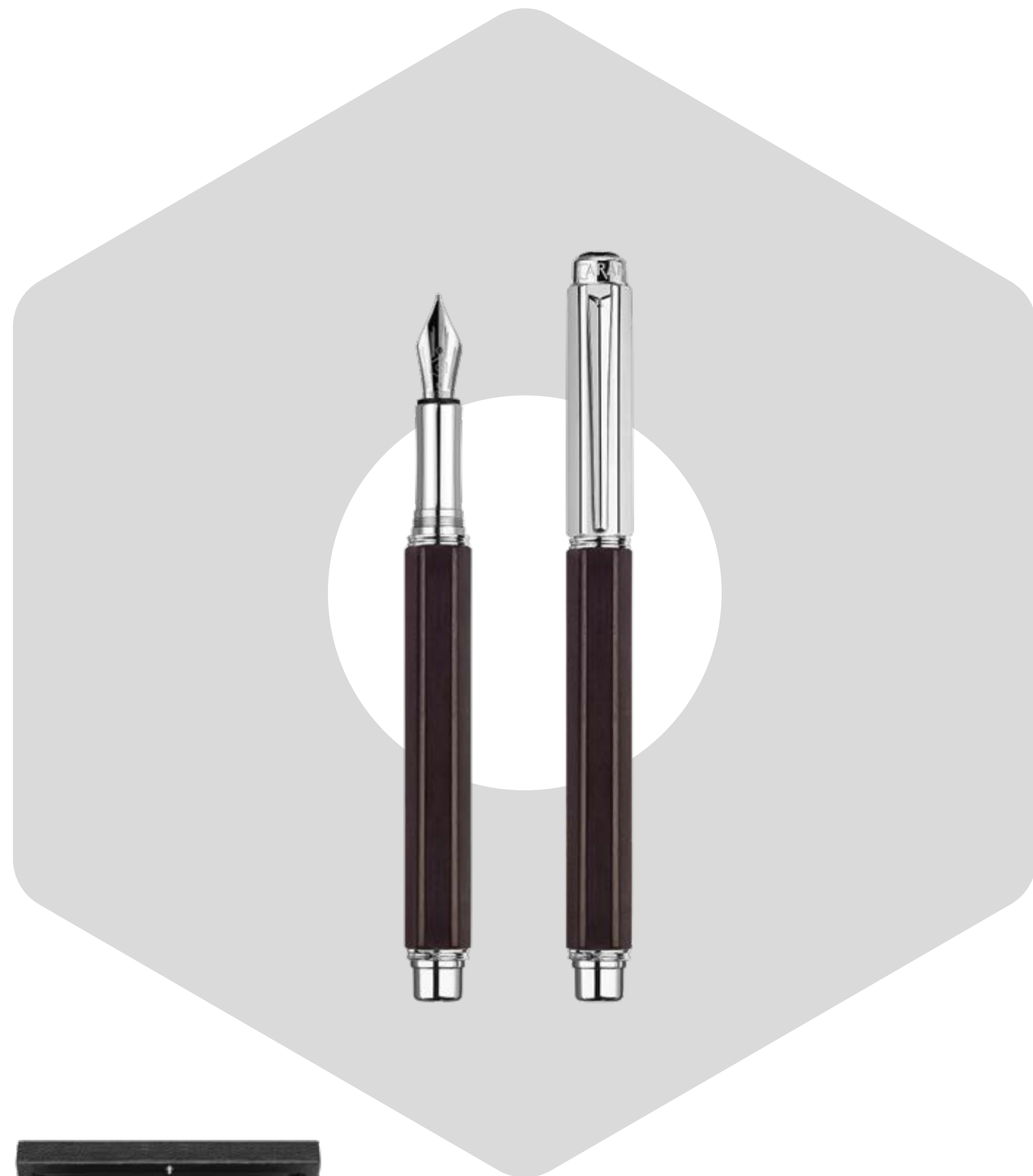

THE CASE
VARIUS

19.5 x 9.7 x 6.5 cm
Standard screen-printed case
Includes:
- the user guide / warranty
- two blue ink cartridges or one black Rollerball fine tip refill
or one black M Goliath refill



VARIUS EBONY
SILVER-PLATED,
RHODIUM-COATED FINISH

FOUNTAIN PEN / M - 4490.086

Nib sizes: BB - .106 / B - .096 / F - .076 / EF - .066 / OM - .056 / OB - .046
Nib: 18-carat gold, rhodium-coated
Cap: Screw
Piston ink pump or ink cartridge
Refill: Ink and cartridges Chromatics Collection (p.136-141)



VARIUS EBONY
SILVER-PLATED,
RHODIUM-COATED FINISH

ROLLER PEN / 4470.086

Cap: Screw
Refills: Rollerball fine tip, Fineliner fine or medium tip blue or black (p.142)



VARIUS EBONY
SILVER-PLATED,
RHODIUM-COATED FINISH

BALLPOINT PEN / 4480.086

Mechanism: Push button
Goliath refills: large, medium or fine (p.142)



VARIUS EBONY
SILVER-PLATED,
RHODIUM-COATED FINISH

MECHANICAL PENCIL / 4460.086

0.7 mm lead
Mechanism: Push button
Refills: 0.7 mm graphite leads, HB or B and replacement erasers (p.143)



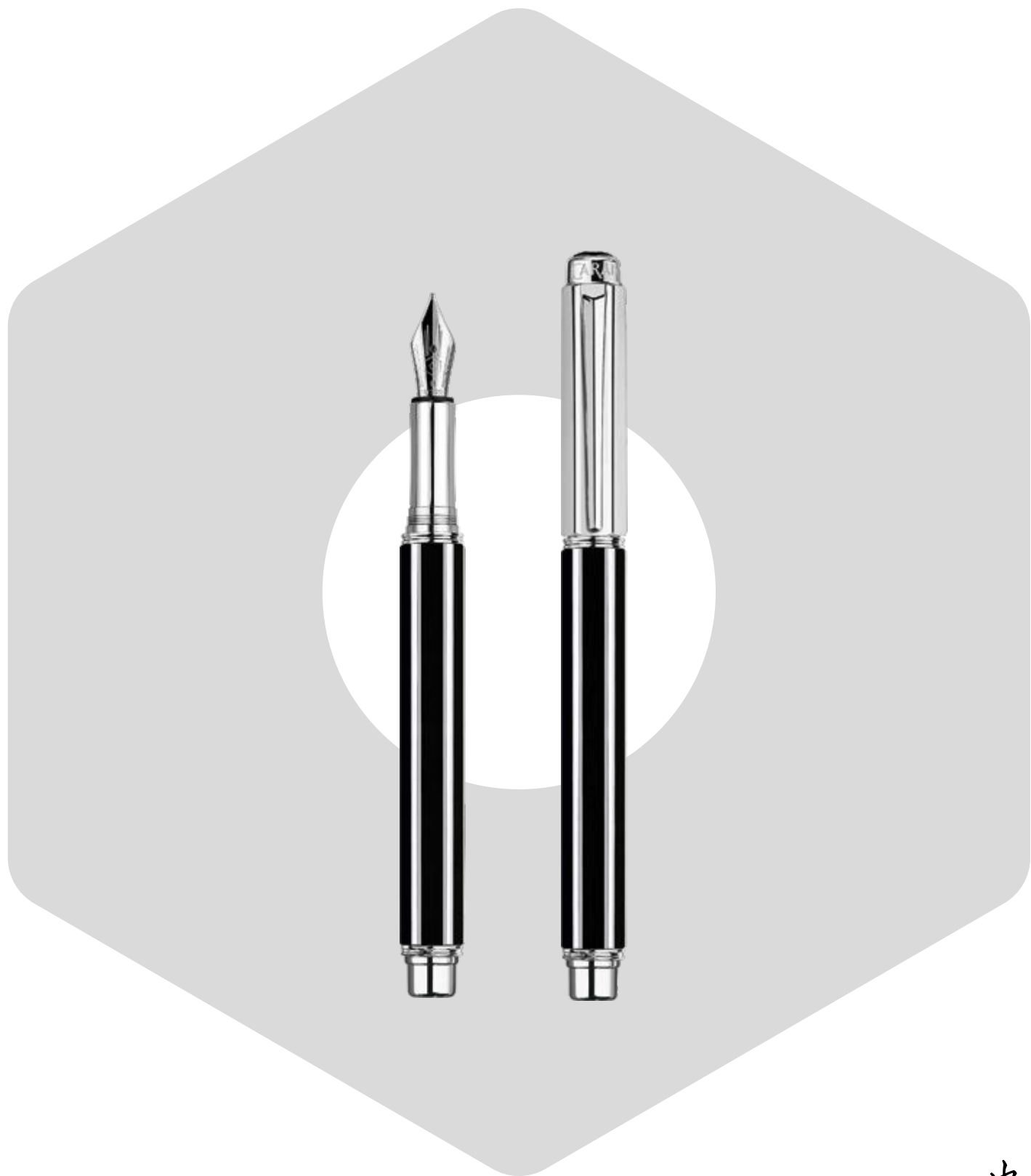

CHINESE LACQUER

Caran d'Ache is proud to be one of the very few Western manufacturers of writing instruments to use this wonderful material. Chinese lacquer gives a magnificent finish to lighters and writing instruments in the Varius collection as well as some limited edition. This natural product is derived from the sap of the "Rhus Vernicifera" tree. Caran d'Ache's craftsmen have been inspired by the highly complex art of preparing and applying it in the manner of the great Eastern masters.

中國漆



VARIUS CHINABLACK
SILVER-PLATED,
RHODIUM-COATED FINISH

FOUNTAIN PEN / M-4490.020

Nib sizes: B - .030 / F - .010 / EF - .990 / OM - .980 / OB - .970
Nib: 18-carat gold, rhodium-coated
Cap: Screw
Piston ink pump or ink cartridge
Refill: Ink and cartridges Chromatics Collection (p.136-141)



VARIUS CHINABLACK
SILVER-PLATED,
RHODIUM-COATED FINISH

ROLLER PEN / 4470.020

Cap: Screw
Refills: Rollerball fine tip, Fineliner fine or medium tip blue or black (p.142)



VARIUS CHINABLACK
SILVER-PLATED,
RHODIUM-COATED FINISH

BALLPOINT PEN / 4480.020

Mechanism: Push button
Goliath refills: large, medium or fine (p.142)



VARIUS CHINABLACK
SILVER-PLATED,
RHODIUM-COATED FINISH

MECHANICAL PENCIL / 4460.020

0.7 mm lead
Mechanism: Push button
Refills: 0.7 mm graphite leads, HB or B and replacement erasers (p.143)





CHINESE LACQUER

Caran d'Ache is proud to be one of the very few Western manufacturers of writing instruments to use this wonderful material. Chinese lacquer gives a magnificent finish to lighters and writing instruments in the Varius collection as well as some limited edition. This natural product is derived from the sap of the "Rhus Vernicifera" tree. Caran d'Ache's craftsmen have been inspired by the highly complex art of preparing and applying it in the manner of the great Eastern masters.

中國漆



VARIUS CHINABLACK
GOLD-PLATED FINISH

FOUNTAIN PEN / M-4490.018

Nib sizes: B - .028 / F - .008 / EF - .998 / OM - .988 / OB - .978
 Nib: 18-carat gold, gold-plated
 Cap: Screw
 Piston ink pump or ink cartridge
 Refill: Ink and cartridges Chromatics Collection (p.136-141)



VARIUS CHINABLACK
GOLD-PLATED FINISH

ROLLER PEN / 4470.018

Cap: Screw
 Refills: Rollerball fine tip, Fineliner fine or medium tip blue or black (p.142)



VARIUS CHINABLACK
GOLD-PLATED FINISH

BALLPOINT PEN / 4480.018

Mechanism: Push button
 Goliath refills: large, medium or fine (p.142)



VARIUS CHINABLACK
GOLD-PLATED FINISH

MECHANICAL PENCIL / 4460.018

0.7 mm lead
 Mechanism: Push button
 Refills: 0.7 mm graphite leads, HB or B and replacement erasers (p.143)



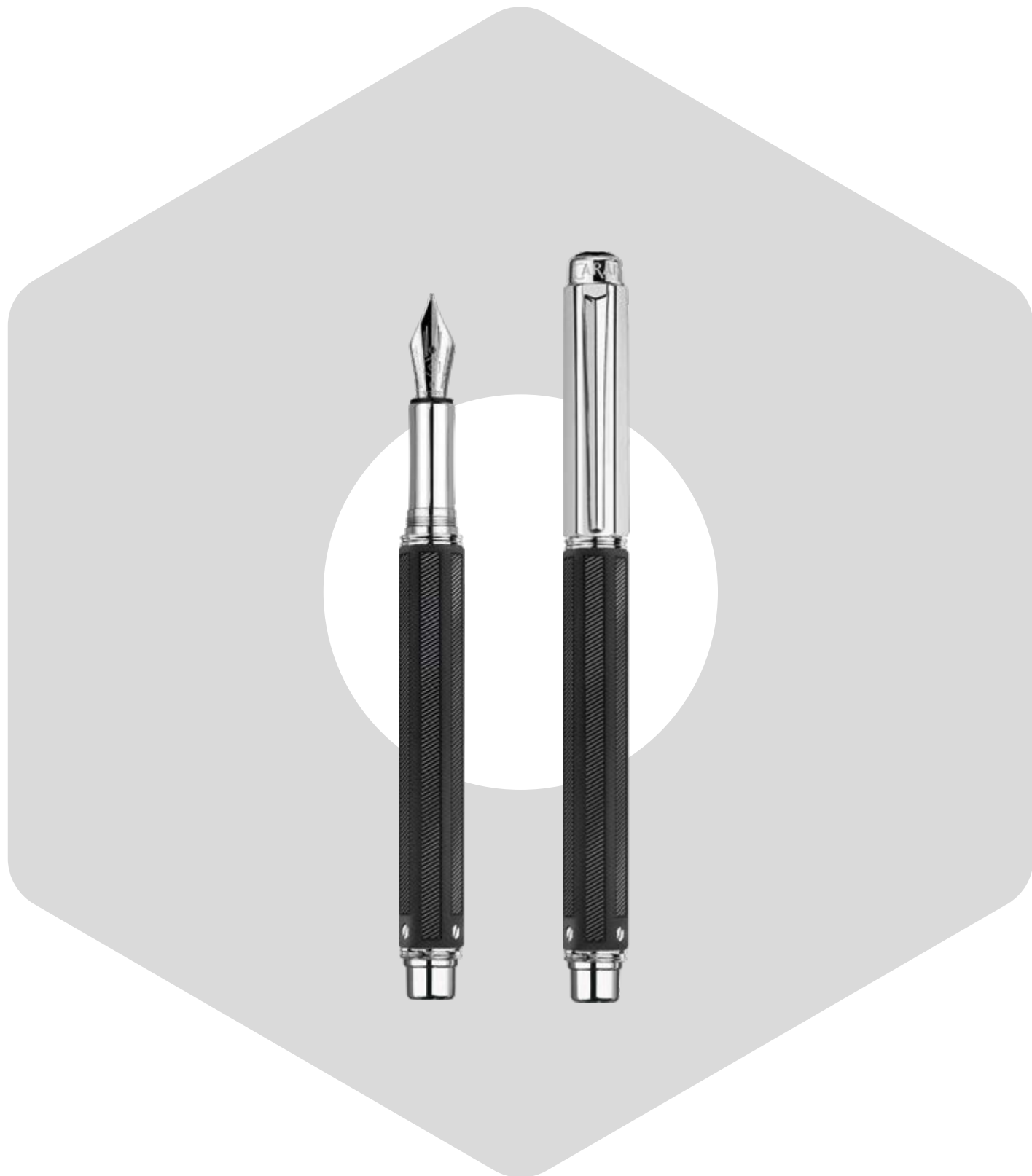

GENUINE RUBBER

This material has a strong character and contemporary, urban elegance. Its inclusion in the Varius design promises an eminently masculine stroke. The brilliant rhodium contrasts with the soft matte rubber allowing the Rubracer to meet the demands and requirements of today's men. A screw inserted in the body of the pen, the articulated clip on the cap, and the broader nib confirm the Varius collection's energy and modernity.



VARIUS RUBRACER
SILVER-PLATED,
RHODIUM-COATED FINISH

FOUNTAIN PEN / M-4490.085

Nib sizes: B-.095 / F-.075 / EF.065 / OM.055 / OB.045 / BB.105
Nib: 18-carat gold, rhodium-coated
Cap: Screw
Piston ink pump or ink cartridge
Refill: Ink and cartridges Chromatics Collection (p.136-141)



VARIUS RUBRACER
SILVER-PLATED,
RHODIUM-COATED FINISH

ROLLER PEN / 4470.085

Cap: Screw
Refills: Rollerball fine tip, Fineliner fine or medium tip blue or black (p.142)



VARIUS RUBRACER
SILVER-PLATED,
RHODIUM-COATED FINISH

BALLPOINT PEN / 4480.085

Mechanism: Push button
Goliath refills: large, medium or fine (p.142)



VARIUS RUBRACER
SILVER-PLATED,
RHODIUM-COATED FINISH

MECHANICAL PENCIL / 4460.085

0.7 mm lead
Mechanism: Push button
Refills: 0.7 mm graphite leads, HB or B and replacement erasers (p.143)



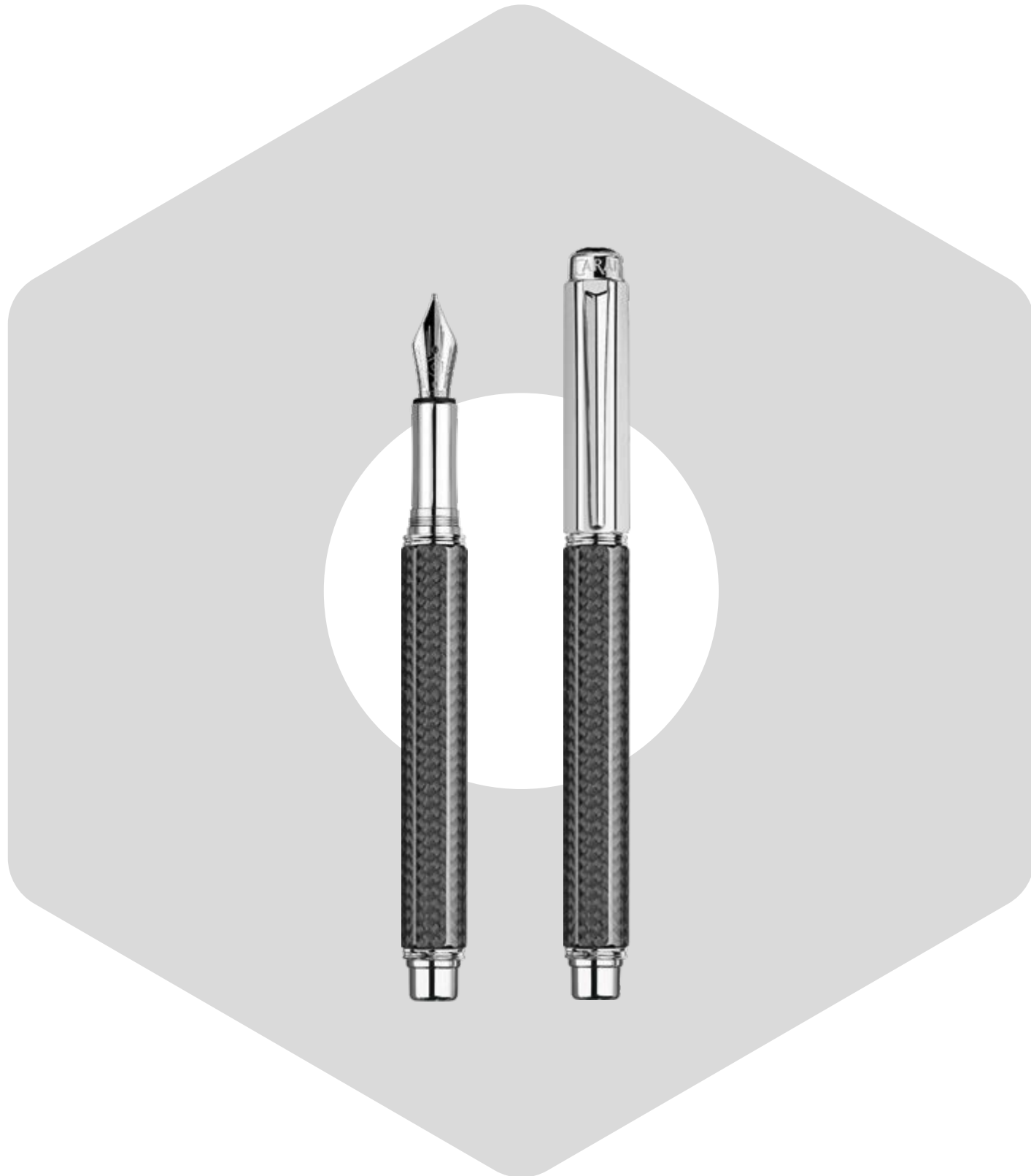

CARBON FIBRE

Carbon fibre is the epitome of a modern material. Its lightness and outstanding rigidity give it an immediate appeal and Caran d'Ache uses it to create a new, high-tech interpretation of tradition. Removed from its normal environment of top-level sports, and linked with silver-plated and rhodium-coated elements, carbon fibre brings power and strength to the Varius line.



VARIUS CARBON
SILVER-PLATED,
RHODIUM-COATED FINISH

FOUNTAIN PEN / M-4490.017

Nib sizes: B - .027 / F - .007 / EF - .997 / OM - .987 / OB - .977
Nib: 18-carat gold, rhodium-coated
Cap: Screw
Piston ink pump or ink cartridge
Refill: Ink and cartridges Chromatics Collection (p.136-141)

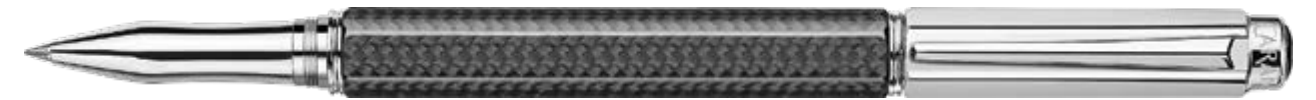

VARIUS CARBON
SILVER-PLATED,
RHODIUM-COATED FINISH

ROLLER PEN / 4470.017

Cap: Screw
Refills: Rollerball fine tip, Fineliner fine or medium tip blue or black (p.142)



VARIUS CARBON
SILVER-PLATED,
RHODIUM-COATED FINISH

BALLPOINT PEN / 4480.017

Mechanism: Push button
Goliath refills: large, medium or fine (p.142)

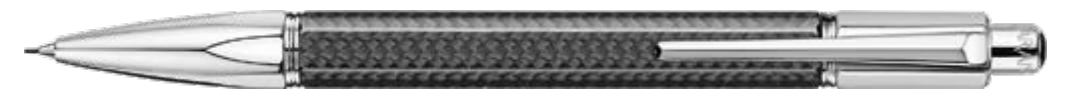

VARIUS CARBON
SILVER-PLATED,
RHODIUM-COATED FINISH

MECHANICAL PENCIL / 4460.017

0.7 mm lead
Mechanism: Push button
Refills: 0.7 mm graphite leads, HB or B and replacement erasers (p.143)



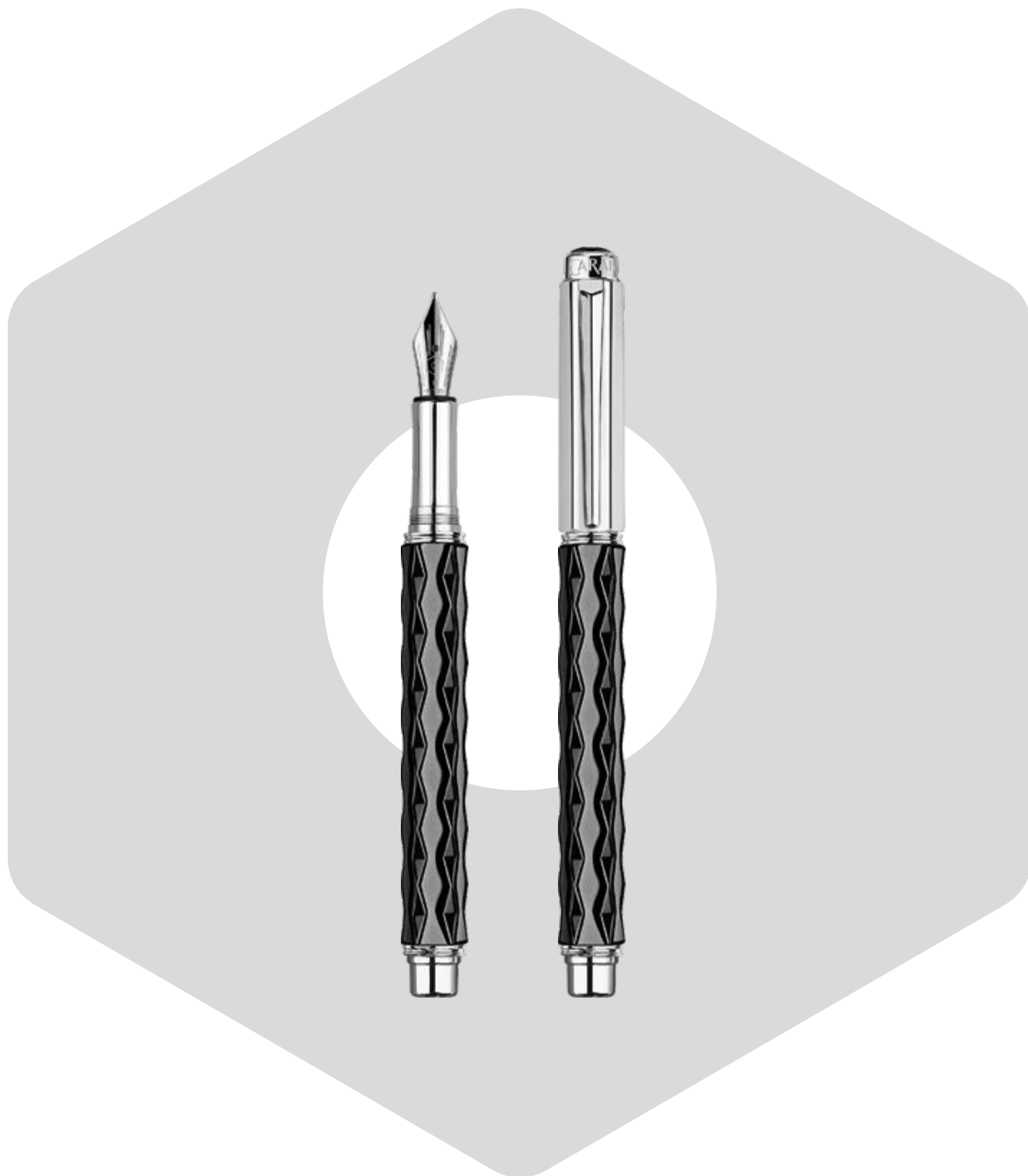

VARIUS CERAMIC BLACK
SILVER-PLATED,
RHODIUM-COATED FINISH

FOUNTAIN PEN / M-4490.109

Nib sizes: B - .119 / F - .099
Nib: 18-carat gold, rhodium-coated
Cap: Screw
Piston ink pump or ink cartridge
Refill: Ink and cartridges Chromatics Collection (p.136-141)



VARIUS CERAMIC BLACK
SILVER-PLATED,
RHODIUM-COATED FINISH

ROLLER PEN / 4470.109

Cap: Screw
Refills: Rollerball fine tip, Fineliner fine or medium tip blue or black (p.142)

CERAMIC

For the past few years, high-tech ceramic has been employed in the production of watch cases. This material is highly valued by the watchmakers for its lightness, its resistance to scratches and its silky touch. When associated with metal, ceramic offers a subtle contrast of materials and an elegant lighting effect.



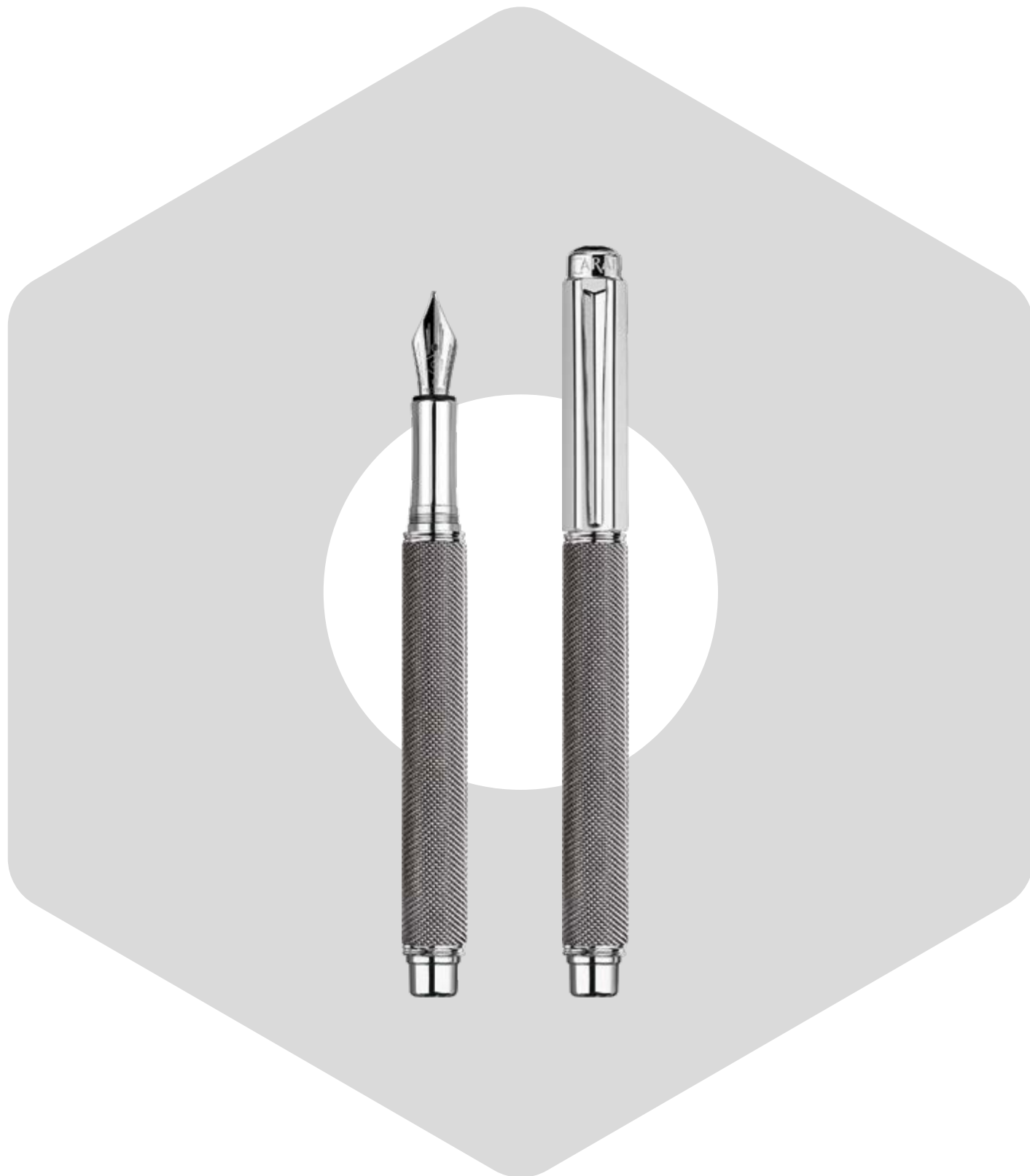

CHAIN MAIL

In its innovative use of chain mail, Caran d'Ache has made the most of this legendary material that once protected medieval knights. Its woven links of stainless steel create a very pleasant texture in the writer's hand. Chain mail even comes in a gold-plated version.



VARIUS IVANHOE
SILVER-PLATED,
RHODIUM-COATED FINISH

FOUNTAIN PEN / M-4490.014

Nib sizes: B - .024 / F - .004 / EF - .994 / OM - .984 / OB - .974
Nib: 18-carat gold, rhodium-coated
Cap: Screw
Piston ink pump or ink cartridge
Refill: Ink and cartridges Chromatics Collection (p.136-141)



VARIUS IVANHOE
SILVER-PLATED,
RHODIUM-COATED FINISH

ROLLER PEN / 4470.014

Cap: Screw
Refills: Rollerball fine tip, Fineliner fine or medium tip blue or black (p.142)



VARIUS IVANHOE
SILVER-PLATED,
RHODIUM-COATED FINISH

BALLPOINT PEN / 4480.014

Mechanism: Push button
Goliath refills: large, medium or fine (p.142)



VARIUS IVANHOE
SILVER-PLATED,
RHODIUM-COATED FINISH

MECHANICAL PENCIL / 4460.014

0.7 mm lead
Mechanism: Push button
Refills: 0.7 mm graphite leads, HB or B and replacement erasers (p.143)



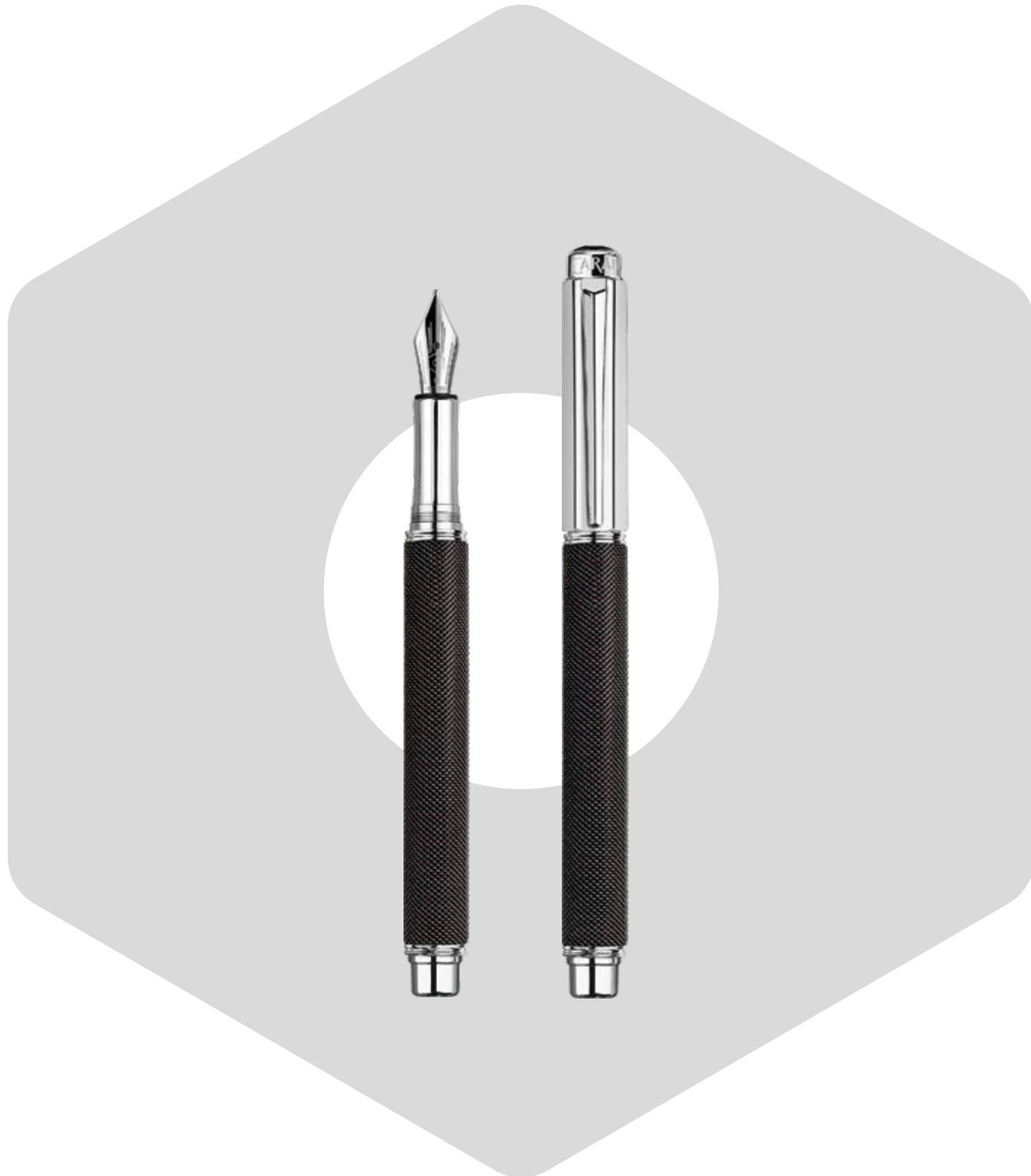

BLACK CHAIN MAIL

The body of the Varius Ivanhoe Black is covered in a micro-woven chain mail in deep black stainless steel (a Milanese sheath). Using a highly advanced technology, Caran d'Ache craftsmen have treated the steel to receive a black PVD coating that is both strong and beautiful. This process colours the fundamental structure of the steel giving it an extraordinary fineness that will remain eternally unchanged.



VARIUS IVANHOE BLACK
SILVER-PLATED,
RHODIUM-COATED FINISH

FOUNTAIN PEN / M-4490.082

Nib sizes: B - .092 / F - .072 / EF - .062 / OM - .052 / OB - .042
Nib: 18-carat gold, rhodium-coated
Cap: Screw
Piston ink pump or ink cartridge
Refill: Ink and cartridges Chromatics Collection (p.136-141)



VARIUS IVANHOE BLACK
SILVER-PLATED,
RHODIUM-COATED FINISH

ROLLER PEN / 4470.082

Cap: Screw
Refills: Rollerball fine tip, Fineliner fine or medium tip blue or black (p.142)



VARIUS IVANHOE BLACK
SILVER-PLATED,
RHODIUM-COATED FINISH

BALLPOINT PEN / 4480.082

Mechanism: Push button
Goliath refills: large, medium or fine (p.142)



VARIUS IVANHOE BLACK
SILVER-PLATED,
RHODIUM-COATED FINISH

MECHANICAL PENCIL / 4460.082

0.7 mm lead
Mechanism: Push button
Refills: 0.7 mm graphite leads, HB or B and replacement erasers (p.143)





LÉMAN

An expert in colours and media dedicated to the fine arts, Caran d'Ache also calls on all its talent to design writing instruments in exceptional colours. Since 1998, the Léman collection has embodied the richness of chromatic variations illuminating the shores of the lake so dear to the inhabitants of Geneva. A veritable homage to the most beautiful shades that nature has to offer, the Léman collection combines stunningly coloured varnishes with the brilliance of precious metals. Hand polished by the company's craftsmen, these writing instruments can also be enhanced through traditional guillochage and lacquering know-how, offering an explosion of shades and curves. Caran d'Ache has enhanced its collection of Haute Écriture Léman instruments with the Léman Slim range boasting a slender, refined outline for light and delicate writing comfort.

- Two collections: Léman & Léman Slim
- Four writing instruments per collection:
 - Fountain pen, roller pen, ballpoint pen and mechanical pencil
 - Body and cap made of thick gauge brass in different colours and finishes
 - Articulated clip, using a spring mechanism
 - Gold-plated or silver-plated, rhodium-coated finishes
 - Fountain pen nib in 18-carat gold, in four different widths: F, M, B, (BB – Léman only and on request)
- Can be customised by means of personalised engraving
- International warranty
- Swiss Made

For more than 20 years, Caran d'Ache has been giving a brilliant tribute to the most beautiful shades of the Lake Geneva. Writing instruments elevated to the rank of must by the fusion of precious ancestral know-how emblematic of Caran d'Ache: the art of lacquering and guilloché. With Léman Bleu Marin, Caran d'Ache invites writing fans on a soothing journey as the unfathomable waters ripple in the wake of adventurous boats. Adorned in navy blue lacquer, its body displays a deeply textured guilloché for the very first time, subtly calling to mind the sailing boats scattered over the water.

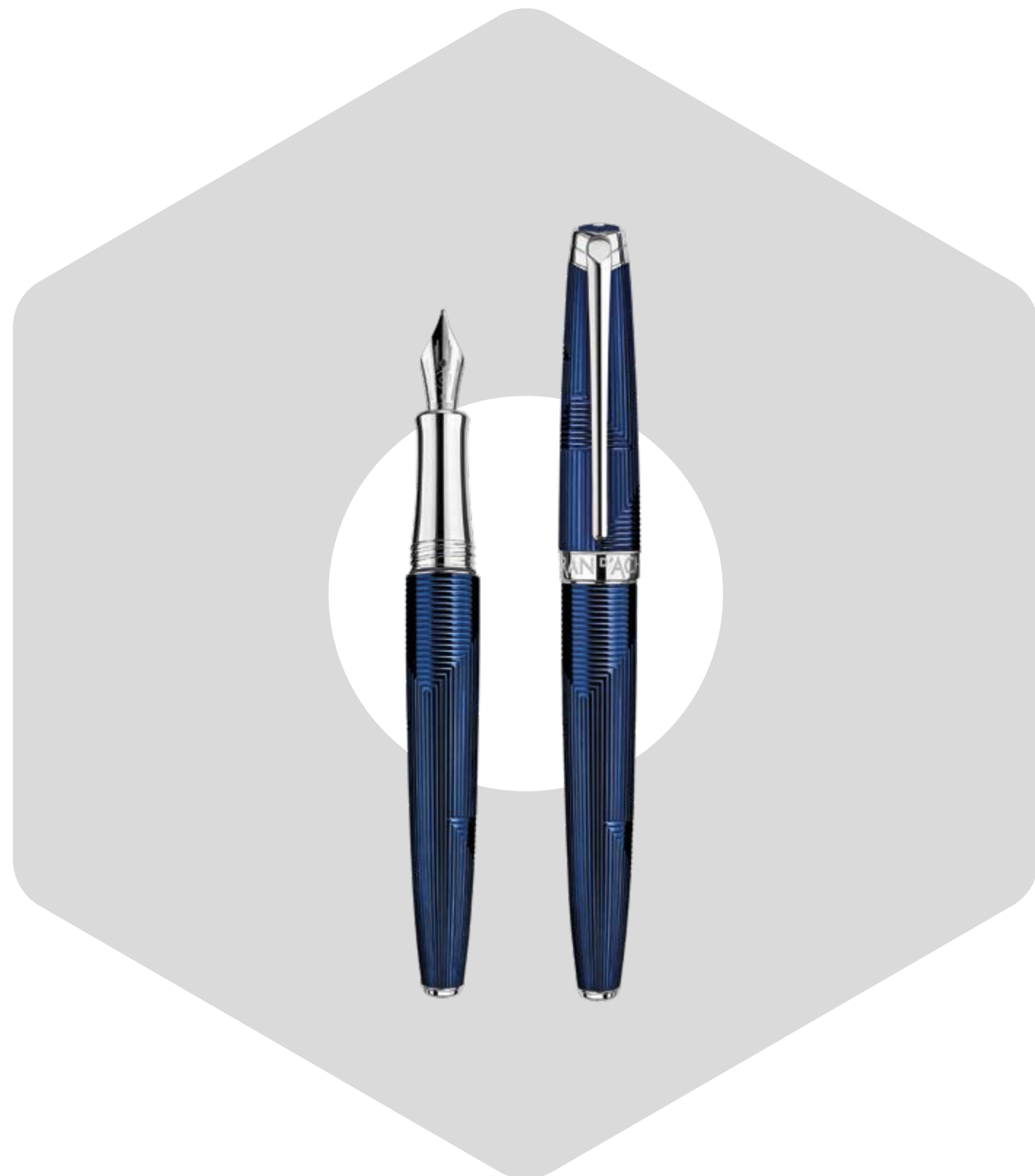

LÉMAN BLEU MARIN
SILVER-PLATED,
RHODIUM-COATED FINISH

FOUNTAIN PEN / M - 4799.169

Nib sizes: B -.159 / F -.179
Nib: 18-carat gold, rhodium-coated
Cap: Screw
Fountain pen – piston ink pump or ink cartridge
Refills: Ink and cartridges Chromatics Collection (p.136-141)



LÉMAN BLEU MARIN
SILVER-PLATED,
RHODIUM-COATED FINISH

ROLLER PEN / 4779.169

Cap: Screw
Refills: Rollerball fine tip, Fineliner fine or medium tip, blue or black (p.142)



LÉMAN BLEU MARIN
SILVER-PLATED,
RHODIUM-COATED FINISH

BALLPOINT PEN / 4789.169

Mechanism: Rotary
Goliath refills: large, medium or fine (p.142)



THE CASE
LÉMAN

18,4 x 8 x 4 cm
Standard screen-printed case
Includes:
- the user guide / warranty
- two blue ink cartridges or one black Rollerball fine tip refill or a black M Goliath refill



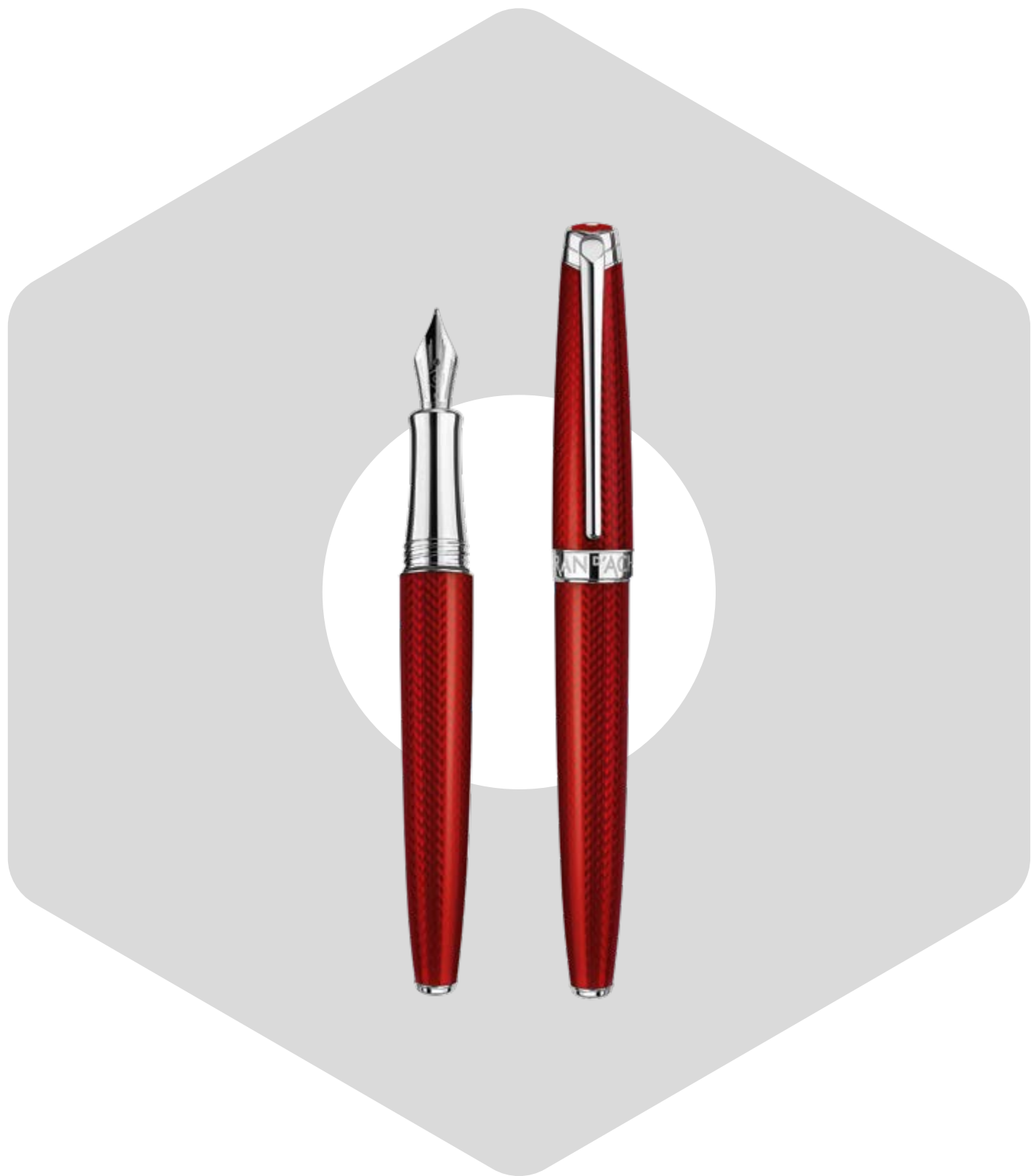

LÉMAN ROUGE CARMIN
SILVER-PLATED,
RHODIUM-COATED FINISH

FOUNTAIN PEN / M – 4799.580

Nib sizes: F -.570 / B -.590
Nib: 18-carat gold, rhodium-coated
Cap: Screw
Fountain pen – piston ink pump or ink cartridge
Refills: Ink and cartridges Chromatics Collection (p.136-141)



LÉMAN ROUGE CARMIN
SILVER-PLATED,
RHODIUM-COATED FINISH

ROLLER PEN / 4779.580

Cap: Screw
Refills: Rollerball fine tip, Fineliner fine or medium tip blue or black (p.142)



LÉMAN ROUGE CARMIN
SILVER-PLATED,
RHODIUM-COATED FINISH

BALLPOINT PEN / 4789.580

Mechanism: Rotary
Goliath refills: large, medium or fine (p.142)

A flamboyant body coated in translucent red lacquer and a cascade of cubic shapes subtly embody the shimmering reflections of Lake Geneva.





LÉMAN DE NUIT
SILVER-PLATED,
RHODIUM-COATED FINISH

FOUNTAIN PEN / M – 4799.019
Nib sizes: B -.029 / F -.009 / BB -.039
Nib: 18-carat gold, rhodium-coated
Cap: Screw
Fountain pen – piston ink pump or ink cartridge
Refills: Ink and cartridges Chromatics Collection (p.136-141)



LÉMAN DE NUIT
SILVER-PLATED,
RHODIUM-COATED FINISH

ROLLER PEN / 4779.019
Cap: Screw
Refills: Rollerball fine tip, Fineliner fine or medium tip blue or black (p.142)



LÉMAN DE NUIT
SILVER-PLATED,
RHODIUM-COATED FINISH

BALLPOINT PEN / 4789.019
Mechanism: Rotary
Goliath refills: large, medium or fine (p.142)



LÉMAN DE NUIT
SILVER-PLATED,
RHODIUM-COATED FINISH

MECHANICAL PENCIL / 4769.019
0.7 mm graphite leads
Mechanism: Rotary
Refills: 0.7 mm graphite leads, HB or B and replacement erasers (p.143)

The translucent black lacquer of the Léman de Nuit anniversary edition reveals the meticulous engraving work of Caran d'Ache's master-artisans.



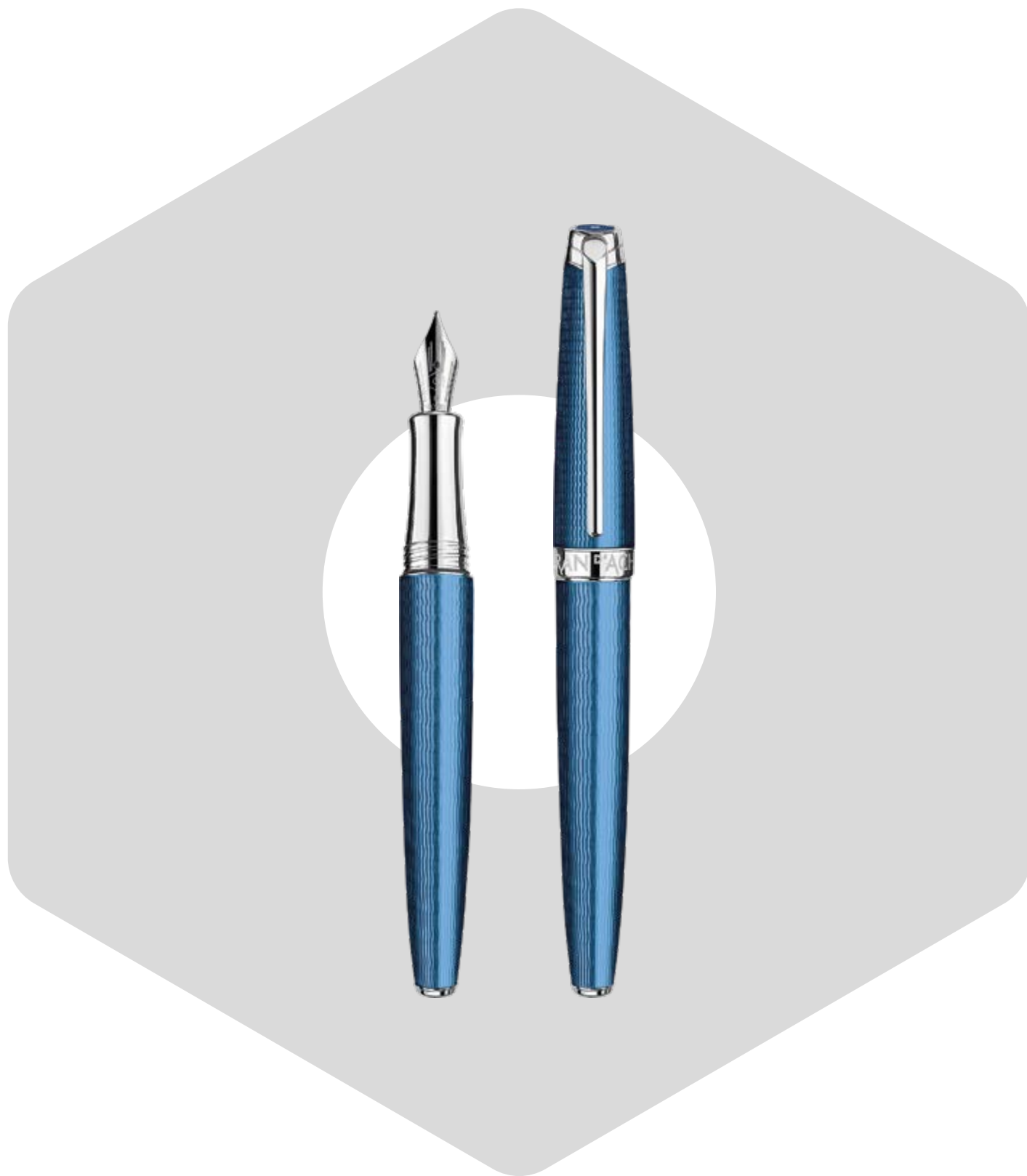

LÉMAN GRAND BLEU
SILVER-PLATED,
RHODIUM-COATED FINISH

FOUNTAIN PEN / M - 4799.168

Nib sizes: B -.178 / F -.158 / BB -.188
Nib: 18-carat gold, rhodium-coated
Cap: Screw
Fountain pen – piston ink pump or ink cartridge
Refills: Ink and cartridges Chromatics Collection (p.136-141)



LÉMAN GRAND BLEU
SILVER-PLATED,
RHODIUM-COATED FINISH

ROLLER PEN / 4779.168

Cap: Screw
Refills: Rollerball fine tip, Fineliner fine or medium tip blue or black (p.142)



LÉMAN GRAND BLEU
SILVER-PLATED,
RHODIUM-COATED FINISH

BALLPOINT PEN / 4789.168

Mechanism: Rotary
Goliath refills: large, medium or fine (p.142)



LÉMAN GRAND BLEU
SILVER-PLATED,
RHODIUM-COATED FINISH

MECHANICAL PENCIL / 4769.168

0.7 mm graphite leads
Mechanism: Rotary
Refills: 0.7 mm graphite leads, HB or B and replacement erasers (p.143)

Underneath a layer of translucent lacquer, reminiscent of the intense blue of the ocean depths, delicate undulating reflections appear on the body of the Léman Grand Bleu.



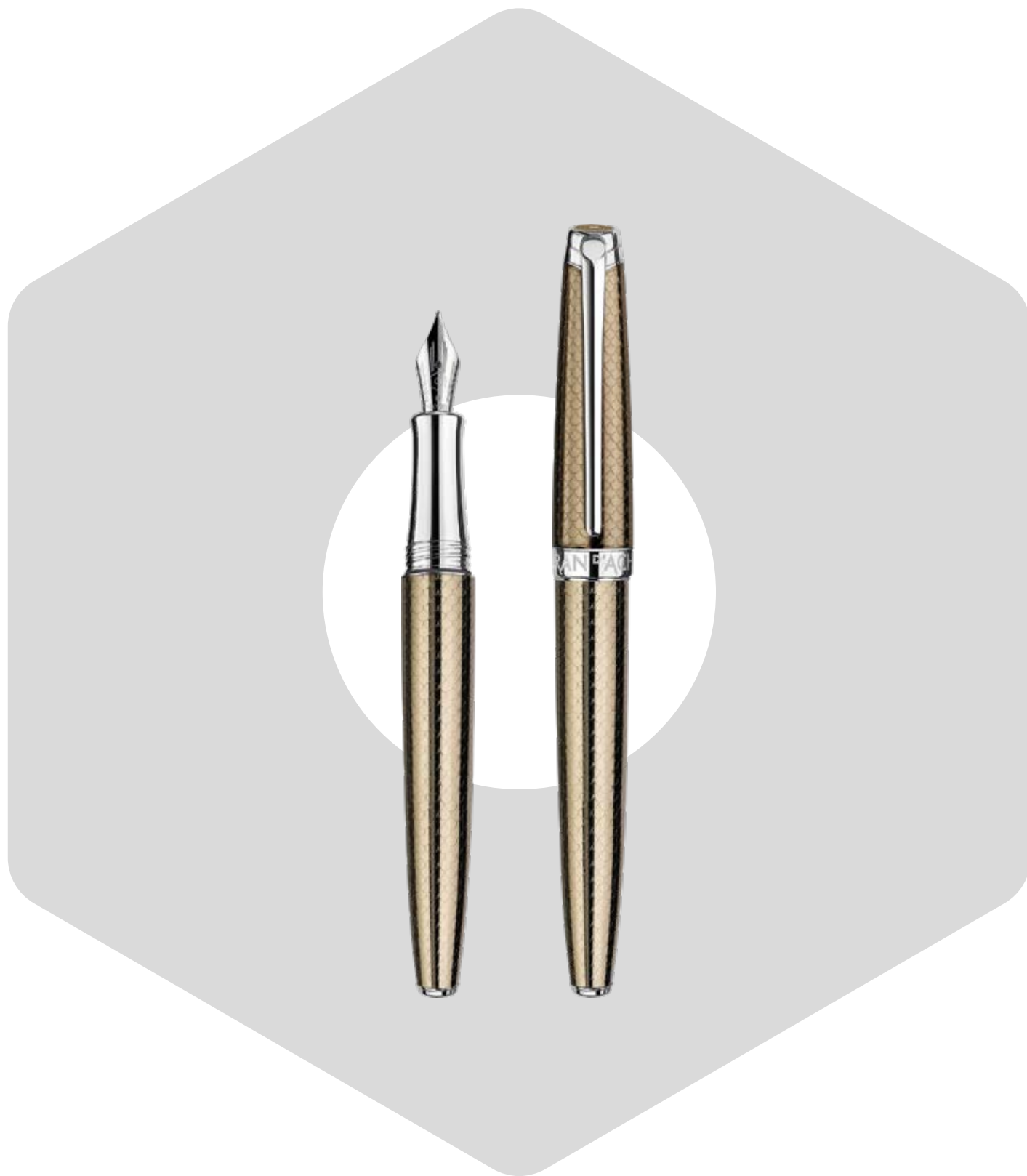

LÉMAN CAVIAR
SILVER-PLATED,
RHODIUM-COATED FINISH

FOUNTAIN PEN / M - 4799.497
Nib sizes: B -.507 / F -.487 / BB -.517
Nib: 18-carat gold, rhodium-coated
Cap: Screw
Fountain pen – piston ink pump or ink cartridge
Refills: Ink and cartridges Chromatics Collection (p.136-141)



LÉMAN CAVIAR
SILVER-PLATED,
RHODIUM-COATED FINISH

ROLLER PEN / 4779.497
Cap: Screw
Refills: Rollerball fine tip, Fineliner fine or medium tip blue or black (p.142)



LÉMAN CAVIAR
SILVER-PLATED,
RHODIUM-COATED FINISH

BALLPOINT PEN / 4789.497
Mechanism: Rotary
Goliath refills: large, medium or fine (p.142)



LÉMAN CAVIAR
SILVER-PLATED,
RHODIUM-COATED FINISH

MECHANICAL PENCIL / 4769.497
0.7 mm graphite leads
Mechanism: Rotary
Refills: 0.7 mm graphite leads, HB or B and replacement erasers (p.143)

The Léman Caviar, a subtle harmonisation of coating and guilloché techniques, reveals fine engraving beneath a transparent grey varnish, giving rise to some surprising metallised reflections.



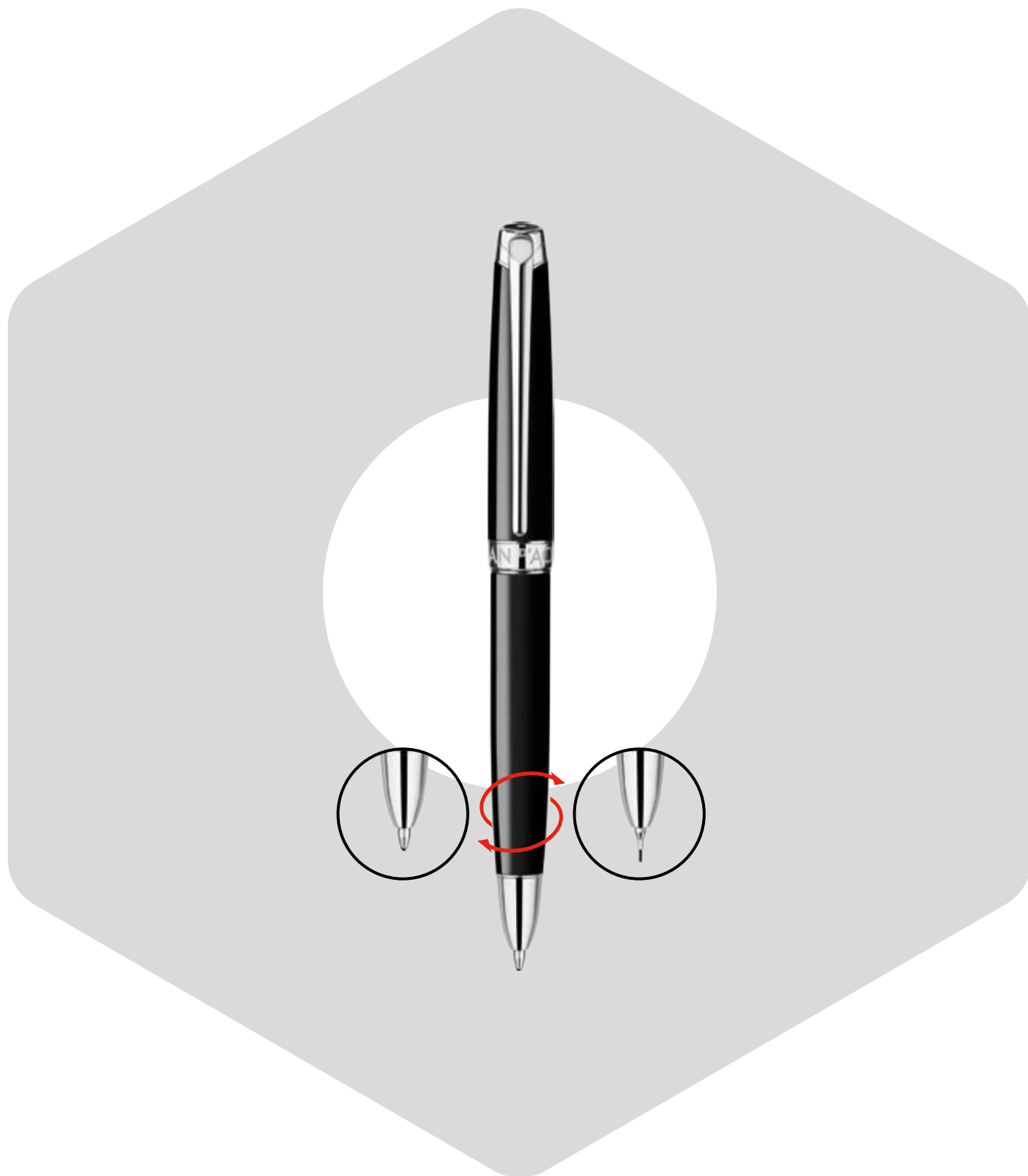

LÉMAN BI-FONCTION EBONY BLACK
SILVER-PLATED,
RHODIUM-COATED FINISH

BI-FUNCTION / 4759.782

Mechanism: Rotary
Refill and 0.7 mm graphite leads
Refill: Bi-fonction / XS
Lead refill: 0.7 mm graphite leads, HB or B and replacement erasers (p.143)

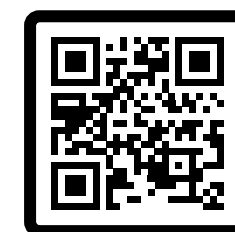

LÉMAN BI-FONCTION EBONY BLACK
INSTRUCTIONS

DEMO VIDEO

A demonstration video explaining the use of the writing instrument is available by scanning the QR Code and on the website of Caran d'Ache: www.carandache.com/lemanbifonction

DUAL FONCTIONALITY

With the Léman Bi-fonction, the Maison Caran Ache once again enriches its Haute Écriture Léman collection of writing instruments, thus highlighting its know-how in the fields of writing and graphite. Behind the original design of the Léman collection is a resolutely unique and powerful writing instrument equipped with a graphite lead refill and a ball cartridge. This dual functionality offers the users of the Léman Bi-fonction a quick transition between the ballpoint pen and the mechanical pencil. A single twist of the body of the instrument reveals the lead, while a twist in the opposite direction reveals the ballpoint. Thanks to this unique writing instrument, graphite aficionados will rediscover the flowing lines of this lead without losing any of the convenience of writing with a ballpoint pen.



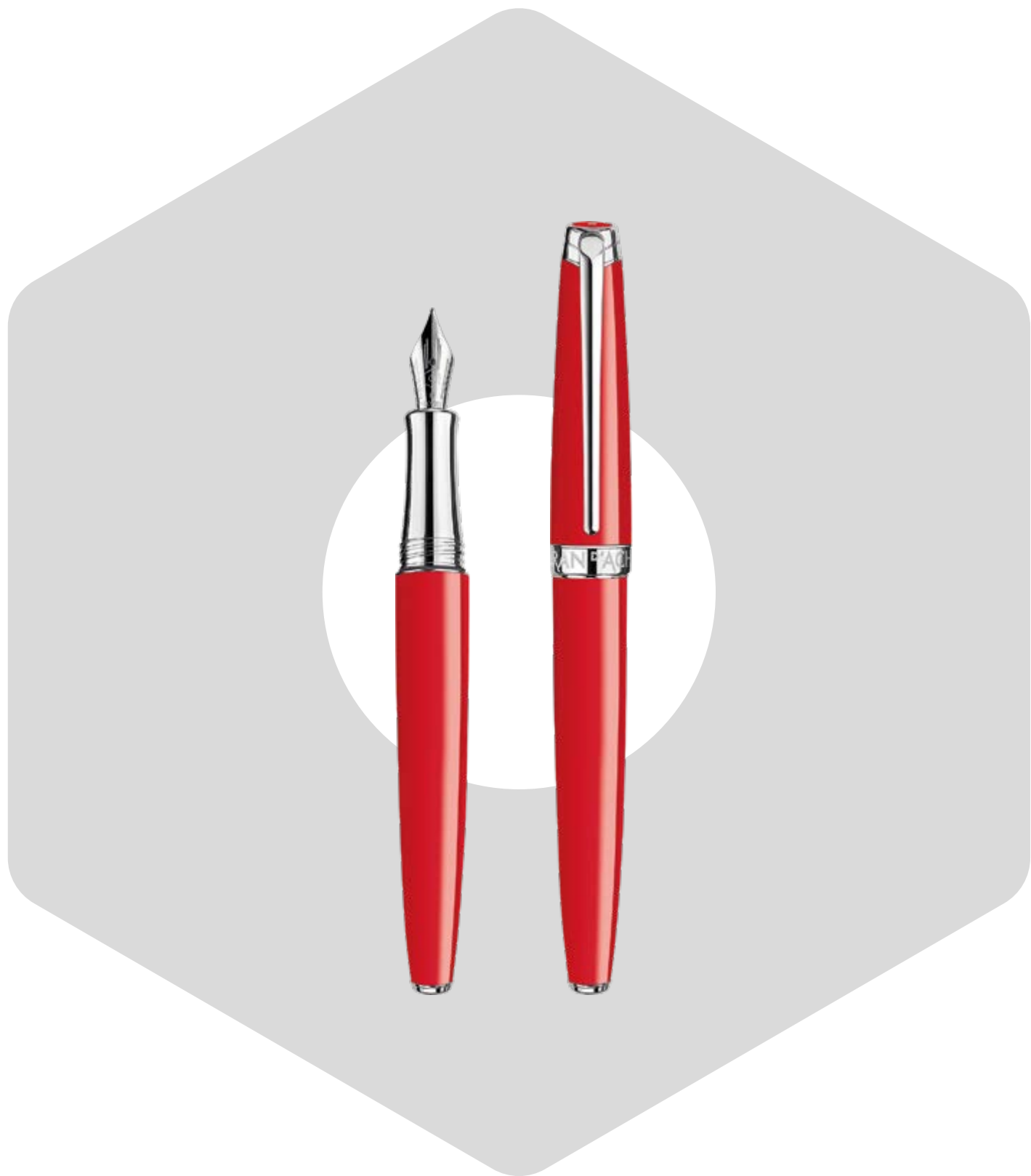

LÉMAN RED
SILVER-PLATED,
RHODIUM-COATED FINISH

FOUNTAIN PEN / M - 4799.770

Nib sizes: B - .780 / F - .760 / BB - .790
Nib: 18-carat gold, rhodium-coated
Cap: Screw
Fountain pen – piston ink pump or ink cartridge
Refills: Ink and cartridges Chromatics Collection (p.136-141)



LÉMAN RED
SILVER-PLATED,
RHODIUM-COATED FINISH

ROLLER PEN / 4779.770

Cap: Screw
Refills: Rollerball fine tip, Fineliner fine or medium tip blue or black (p.142)



LÉMAN RED
SILVER-PLATED,
RHODIUM-COATED FINISH

BALLPOINT PEN / 4789.770

Mechanism: Rotary
Goliath refills: large, medium or fine (p.142)



LÉMAN RED
SILVER-PLATED,
RHODIUM-COATED FINISH

MECHANICAL PENCIL / 4769.770

0.7 mm lead
Mechanism: Rotary
Refills: 0.7 mm graphite leads, HB or B and replacement erasers (p.143)

LACQUER

Lacquer is a precious, refined material that requires great care and attention in its application as well as its finishing. Polished repeatedly, it develops all its wonderful shine in the hands of a craftsman.



LÉMAN BLACK MATT
SILVER-PLATED,
RHODIUM-COATED FINISH

FOUNTAIN PEN / M-4799.496

Nib sizes: B - .506 / F - .486 / BB - .516
Nib: 18-carat gold, rhodium-coated
Cap: Screw
Piston ink pump or ink cartridge
Refills: Ink and cartridges collection
Chromatics (voir p.136-141)



LÉMAN BLUE MATT
SILVER-PLATED,
RHODIUM-COATED FINISH

FOUNTAIN PEN / M-4799.449

Nib sizes: B - .459 / F - .439 / BB .469
Nib: 18-carat gold, rhodium-coated
Cap: Screw
Piston ink pump or ink cartridge
Refills: Ink and cartridges collection
Chromatics (voir p.136-141)



LÉMAN BLACK MATT
SILVER-PLATED,
RHODIUM-COATED FINISH

ROLLER PEN / 4779.496

Cap: Screw
Refills: Rollerball fine tip, Fineliner fine or medium tip blue or black (p.142)



LÉMAN BLACK MATT
SILVER-PLATED, RHODIUM-COATED FINISH

BALLPOINT PEN / 4789.496

Mechanism: Rotary
Goliath refills: large, medium or fine (p.142)



LÉMAN BLACK MATT
SILVER-PLATED,
RHODIUM-COATED FINISH

MECHANICAL PENCIL / 4769.496

0.7 mm lead
Mechanism: Rotary
Refills: 0.7 mm graphite leads, HB or B and replacement erasers (p.143)



LÉMAN BLUE MATT
SILVER-PLATED,
RHODIUM-COATED FINISH

ROLLER PEN / 4779.449

Cap: Screw
Refills: Roller fine, blue or black (p.142)



LÉMAN BLUE MATT
SILVER-PLATED,
RHODIUM-COATED FINISH

BALLPOINT PEN / 4789.449

Mechanism: Rotary
Goliath refills: large, medium or fine (p.142)



LÉMAN BLUE MATT
SILVER-PLATED,
RHODIUM-COATED FINISH

MECHANICAL PENCIL / 4769.449

0.7 mm lead
Mechanism: Rotary
Refills: 0.7 mm graphite leads, HB or B and replacement erasers (p.143)



LÉMAN EBONY BLACK
GOLD-PLATED FINISH

FOUNTAIN PEN / M-4799.282

Nib sizes: B -.292 / F -.272
Nib : 18-carat gold, gold-plated
Mechanism: Rotary
Piston ink pump or ink cartridge
Refills: Ink and cartridges collection
Chromatics (voir p.136-141)



LÉMAN EBONY BLACK
SILVER-PLATED,
RHODIUM-COATED FINISH

FOUNTAIN PEN / M-4799.782

Nib sizes: B -.792 / F -.772 / BB -.802
Nib: 18-carat gold, rhodium-coated
Cap: Screw
Piston ink pump or ink cartridge
Refills: Ink and cartridges
Collection Chromatics (p.136-141)



LÉMAN EBONY BLACK
GOLD-PLATED FINISH

ROLLER PEN / 4779.282

Cap: Screw
Refills: Rollerball fine tip, Fineliner fine or medium tip blue or black (p.142)



LÉMAN EBONY BLACK
GOLD-PLATED FINISH

BALLPOINT PEN / 4789.282

Mechanism: Rotary
Goliath refills: large, medium or fine (p.142)



LÉMAN EBONY BLACK
GOLD-PLATED FINISH

MECHANICAL PENCIL / 4769.282

0.7 mm lead
Mechanism: Rotary
Refills: 0.7 mm graphite leads, HB or B and replacement erasers (p.143)



LÉMAN EBONY BLACK
SILVER-PLATED, RHODIUM-COATED FINISH

ROLLER PEN / 4779.782

Cap: Screw
Refills: Rollerball fine tip, Fineliner fine or medium tip blue or black (p.142)



LÉMAN EBONY BLACK
SILVER-PLATED,
RHODIUM-COATED FINISH

BALLPOINT PEN / 4789.782

Mechanism: Rotary
Goliath refills: large, medium or fine (p.142)



LÉMAN EBONY BLACK
SILVER-PLATED, RHODIUM-COATED FINISH

MECHANICAL PENCIL / 4769.782

0.7 mm lead
Mechanism: Rotary
Refills: 0.7 mm graphite leads, HB or B and replacement erasers (p.143)



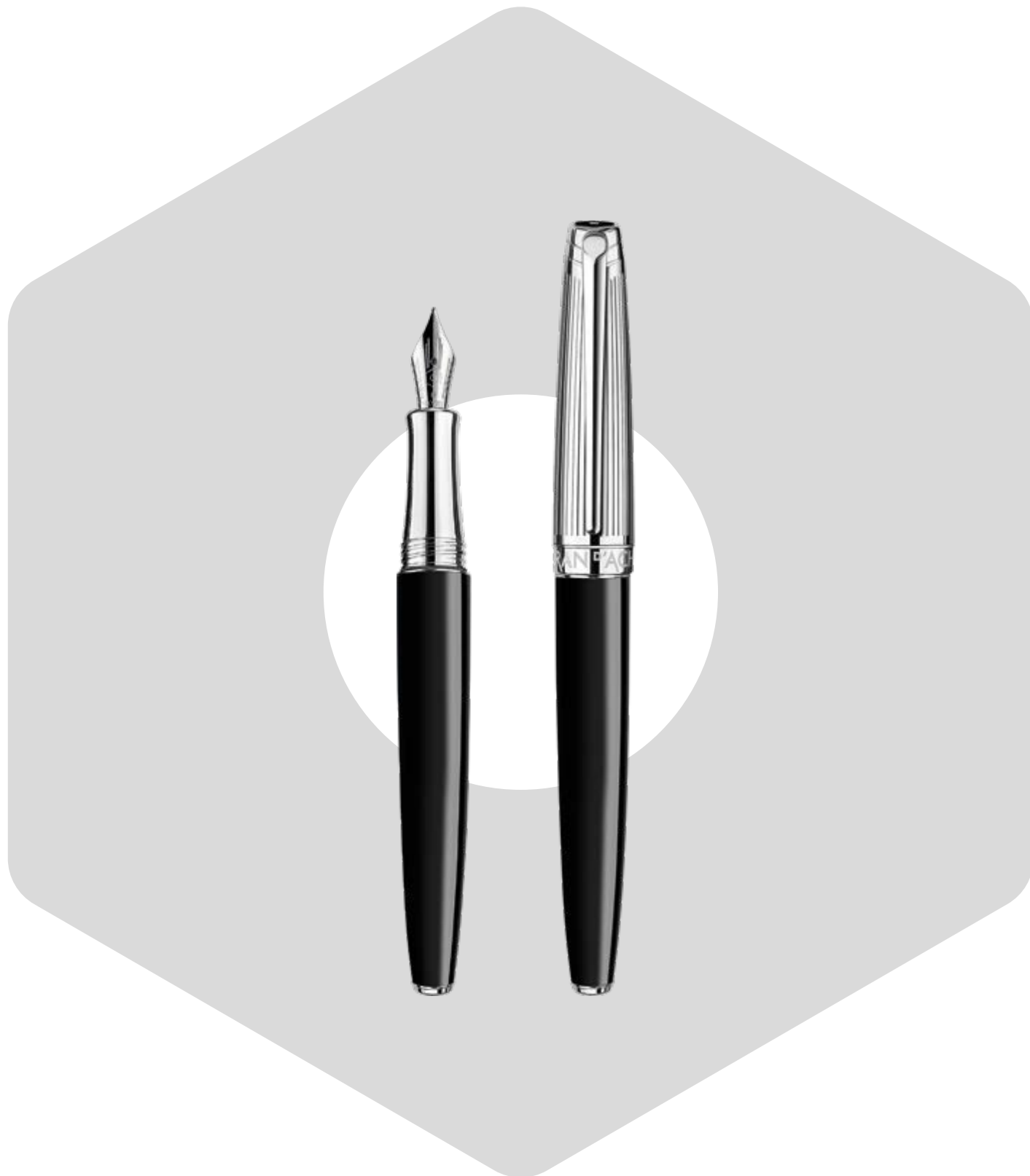

LÉMAN BICOLOR BLACK
SILVER-PLATED,
RHODIUM-COATED FINISH

FOUNTAIN PEN / M-4799.289

Nib sizes: B - .299 / F - .279 / BB - .309
Nib: 18-carat gold, rhodium-coated
Cap: Screw
Piston ink pump or ink cartridge
Refills: Ink and cartridges collection
Chromatics (voir p.136-141)



LÉMAN BICOLOR BLACK
SILVER-PLATED,
RHODIUM-COATED FINISH

ROLLER PEN / 4779.289

Cap: Screw
Refills: Rollerball fine tip, Fineliner fine or medium tip blue or black (p.142)



LÉMAN BICOLOR BLACK
SILVER-PLATED,
RHODIUM-COATED FINISH

BALLPOINT PEN / 4789.289

Mechanism: Rotary
Goliath refills: large, medium or fine (p.142)



LÉMAN BICOLOR BLACK
SILVER-PLATED,
RHODIUM-COATED FINISH

MECHANICAL PENCIL / 4769.289

0.7 mm lead
Mechanism: Rotary
Refills: 0.7 mm graphite leads, HB or B and replacement erasers (p.143)



Instantly recognisable by the finesse of its tapered curves, the Léman Slim Lights is decorated with baguette-cut diamond guilloché of incomparable radiance, plunging you into a world of jewelry full of sparkle and shine. An exceptional article consisting of an endless series of prisms magnifying the work of the Caran d'Ache craftsmen, which is comparable to that of the leading jewelry designers. Available as a fountain pen, ballpoint pen and roller pen, it is the embodiment of Swiss elegance and a subtle blend of tradition, boldness and sophistication.

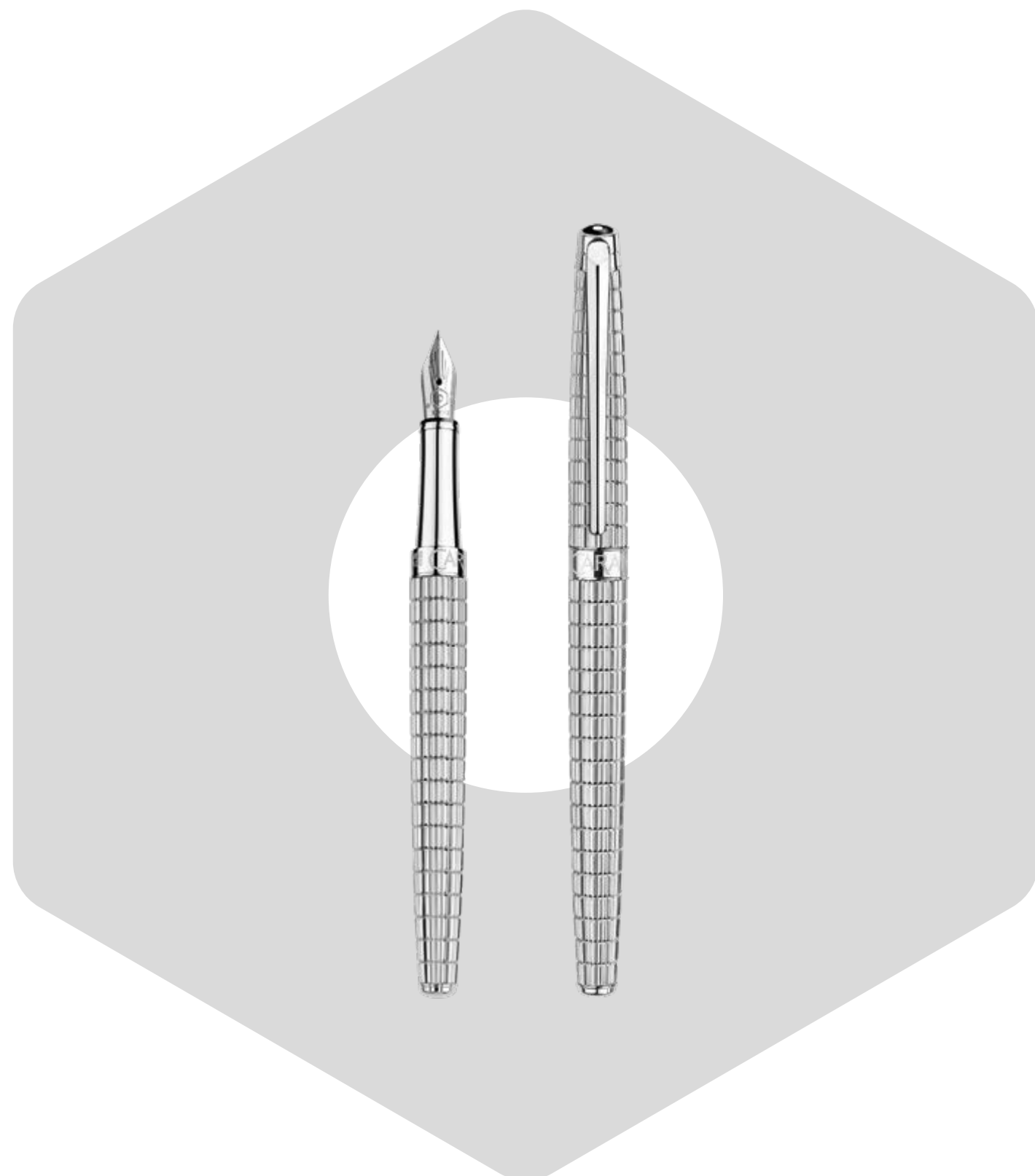

LÉMAN SLIM LIGHTS
SILVER RHODIUM-PLATED FINISH

FOUNTAIN PEN / M - 4791.386

Nib sizes: B -.396 / F -.376
Nib: 18-carat gold, rhodium-coated
Cap: Click-in
Piston ink pump or ink cartridge
Refills: Ink and cartridges Chromatics Collection (p.136-141)



LÉMAN SLIM LIGHTS
SILVER RHODIUM-PLATED FINISH

ROLLER PEN / 4771.386

Cap: Click-in
Refills: Rollerball fine tip, Fineliner fine or medium tip, blue or black (p.142)



LÉMAN SLIM LIGHTS
SILVER RHODIUM-PLATED FINISH

BALLPOINT PEN / 4781.386

Mechanism: Rotative
Goliath refills: large, medium or fine (p.142)



THE CASE
LÉMAN

18,4 x 8 x 4 cm
Standard screen-printed case
Includes:
- the user guide / warranty
- two blue ink cartridges or one black Rollerball fine tip refill or a black M Goliath refill



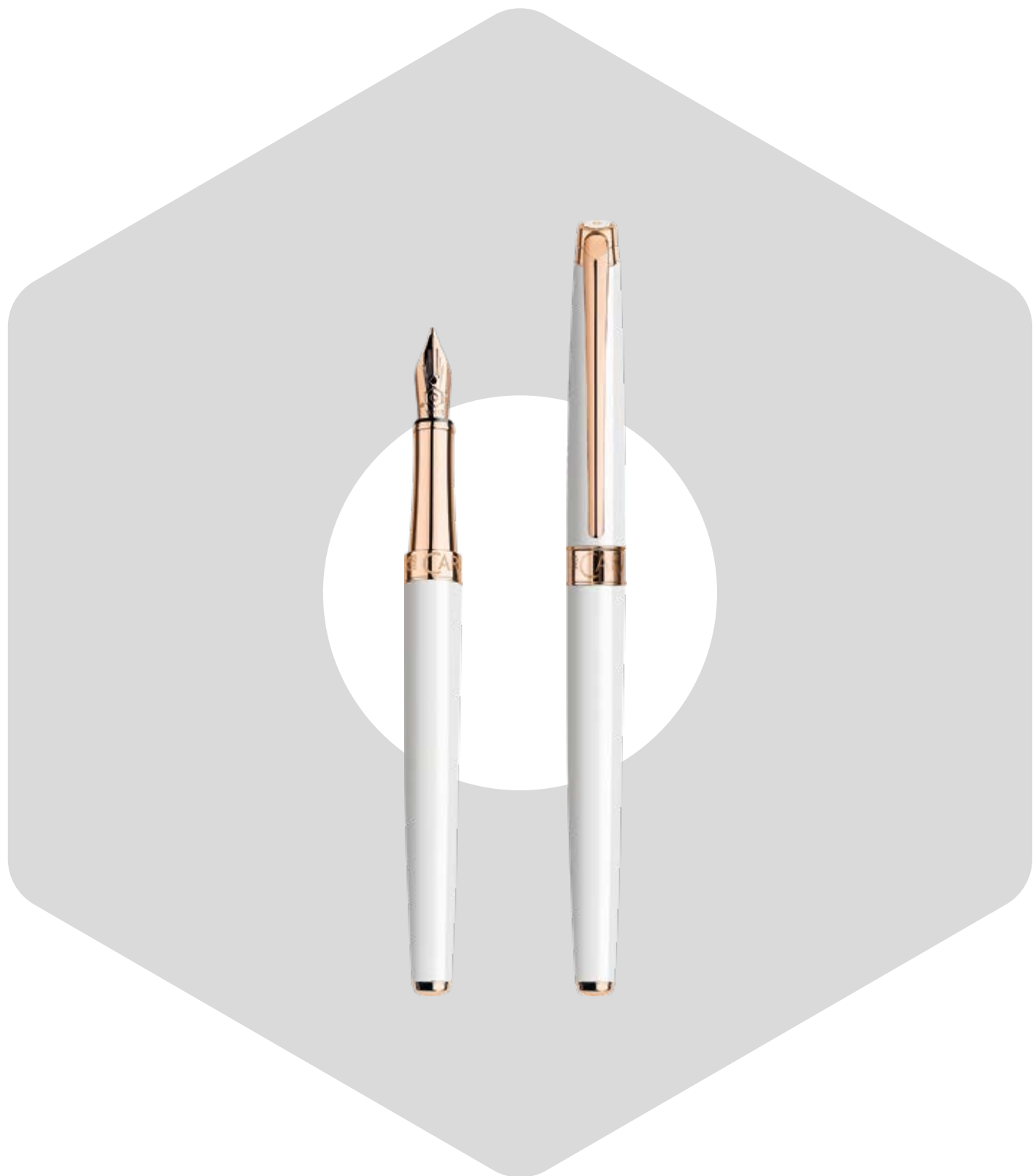

LÉMAN SLIM WHITE
PINK GOLD-PLATING FINISH

FOUNTAIN PEN / M- 4791.001

Nib sizes: B - .011 / F - .991
Nib: 18-carat gold, rose gold-plated
Cap: Click-in
Piston ink pump or ink cartridge
Refills: Ink and cartridges Chromatics Collection (p.136-141)



LÉMAN SLIM WHITE
PINK GOLD-PLATING FINISH

ROLLER PEN / 4771.001

Cap: Click-in
Refills: Rollerball fine tip, Fineliner fine or medium tip blue or black (p.142)



LÉMAN SLIM WHITE
PINK GOLD-PLATING FINISH

BALLPOINT PEN / 4781.001

Mechanism: Rotary
Goliath refills: large, medium or fine (p.142)



LÉMAN SLIM WHITE
PINK GOLD-PLATING FINISH

MECHANICAL PENCIL / 4761.001

0.7 mm lead
Mechanism: Rotary
Refills: 0.7 mm graphite leads, HB or B and replacement erasers (p.143)

LACQUER

Lacquer is a precious, refined material that requires great care and attention in its application as well as its finishing. Polished repeatedly, it develops all its wonderful shine in the hands of a craftsman.



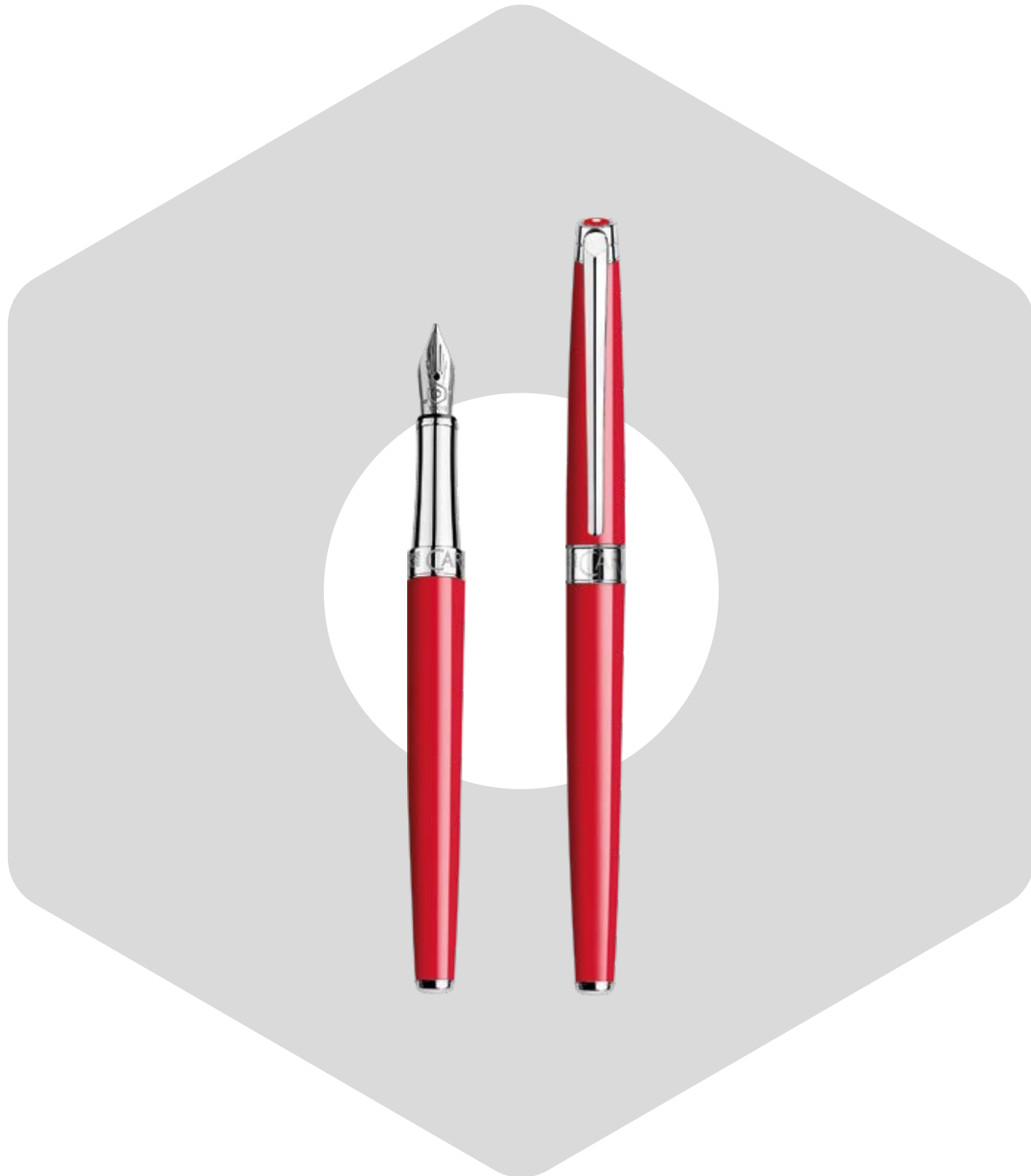

LÉMAN SLIM RED
SILVER-PLATED,
RHODIUM-COATED FINISH

FOUNTAIN PEN / M - 4791.770

Nib sizes: B - .780 / F - .760
Nib: 18-carat gold, rhodium-coated
Cap: Click-in
Piston ink pump or ink cartridge
Refills: Ink and cartridges Chromatics Collection (p.136-141)



LÉMAN SLIM RED
SILVER-PLATED,
RHODIUM-COATED FINISH

ROLLER PEN / 4771.770

Cap: Click-in
Refills: Rollerball fine tip, Fineliner fine or medium tip blue or black (p.142)



LÉMAN SLIM RED
SILVER-PLATED,
RHODIUM-COATED FINISH

BALLPOINT PEN / 4781.770

Mechanism: Rotary
Goliath refills: large, medium or fine (p.142)



LÉMAN SLIM RED
SILVER-PLATED,
RHODIUM-COATED FINISH

MECHANICAL PENCIL / 4761.770

0.7 mm lead
Mechanism: Rotary
Refills: 0.7 mm graphite leads, HB or B and replacement erasers (p.143)

LACQUER

Lacquer is a precious, refined material that requires great care and attention in its application as well as its finishing. Polished repeatedly, it develops all its wonderful shine in the hands of a craftsman.



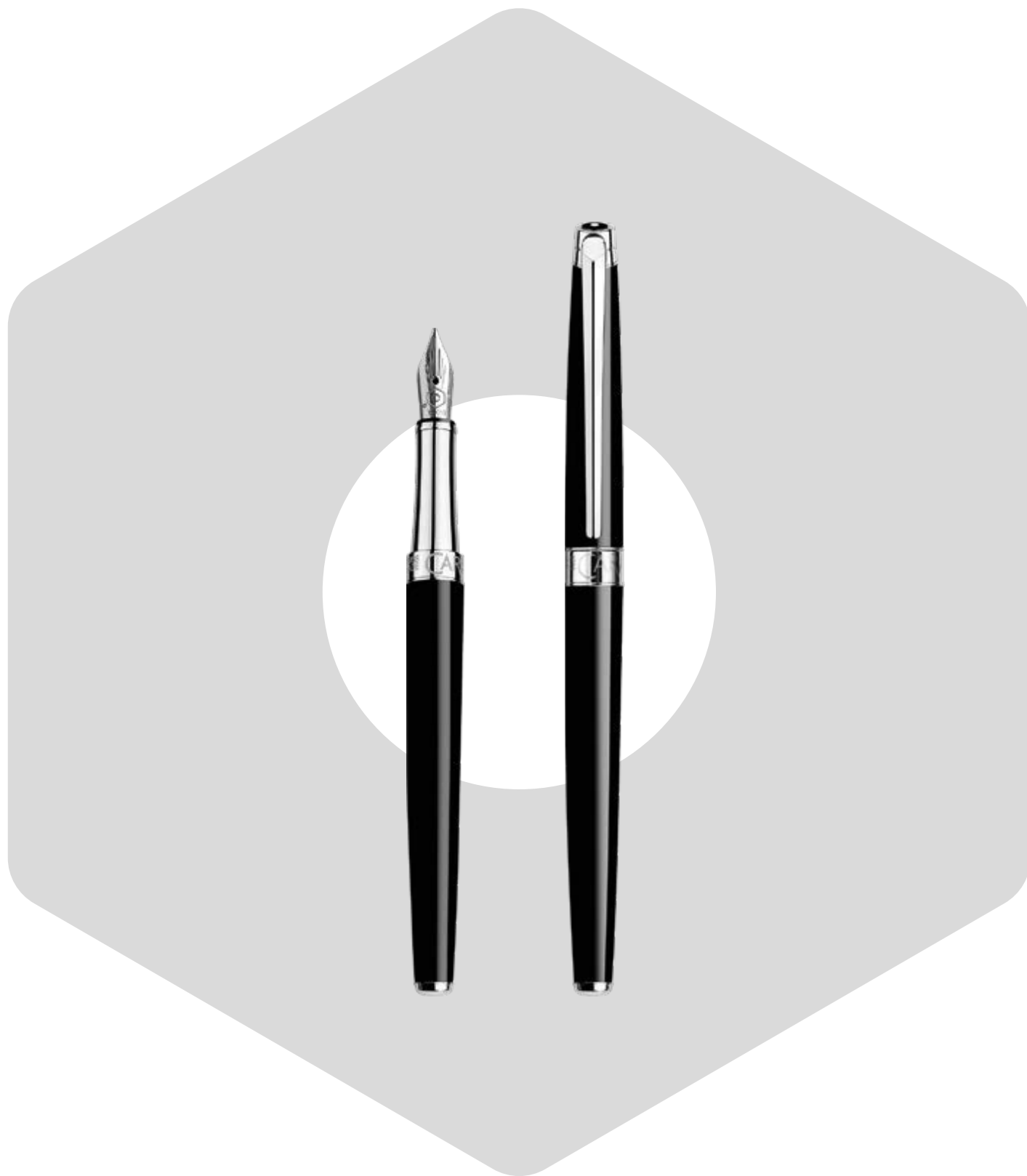

LÉMAN SLIM BLACK
SILVER-PLATED,
RHODIUM-COATED FINISH

FOUNTAIN PEN / M - 4791.782

Nib sizes: B - .792 / F - .772
Nib: 18-carat gold, rhodium-coated
Cap: Click-in
Piston ink pump or ink cartridge
Refills: Ink and cartridges Chromatics Collection (p.136-141)



LÉMAN SLIM BLACK
SILVER-PLATED,
RHODIUM-COATED FINISH

ROLLER PEN / 4771.782

Cap: Click-in
Refills: Rollerball fine tip, Fineliner fine or medium tip blue or black (p.142)



LÉMAN SLIM BLACK
SILVER-PLATED,
RHODIUM-COATED FINISH

BALLPOINT PEN / 4781.782

Mechanism: Rotary
Goliath refills: large, medium or fine (p.142)



LÉMAN SLIM BLACK
SILVER-PLATED,
RHODIUM-COATED FINISH

MECHANICAL PENCIL / 4761.782

0.7 mm lead
Mechanism: Rotary
Refills: 0.7 mm graphite leads, HB or B and replacement erasers (p.143)

LACQUER

Lacquer is a precious, refined material that requires great care and attention in its application as well as its finishing. Polished repeatedly, it develops all its wonderful shine in the hands of a craftsman.





ECRIDOR

Since the 1930s, the Ecridor writing instruments have been emblematic of the precious know-how of Caran d'Ache. Their sober and elegant hexagonal design is inspired by the shape of the pencils so dear to the Geneva-based company. The play of light and sparkle created by the perfect geometry of the symbols, so intense and inspiring, reflects the expertise of the master guillocheurs and polishers who give free rein to their talent. Whatever the metal covering the brass body and whatever the form (fountain pen, roller pen, ballpoint pen or mechanical pencil) and finely-engraved pattern on the instrument, there is an Ecridor to inspire each and every one of you.

- Four writing instruments:
 - Fountain pen, roller pen, ballpoint pen, mechanical pencil
 - Silver, rhodium, palladium and gold-plated attributes
 - Flexible clip
 - Steel nib available in three distinct widths: F, M, B
- Can be customised by means of personalised engraving
- International warranty
- Swiss Made

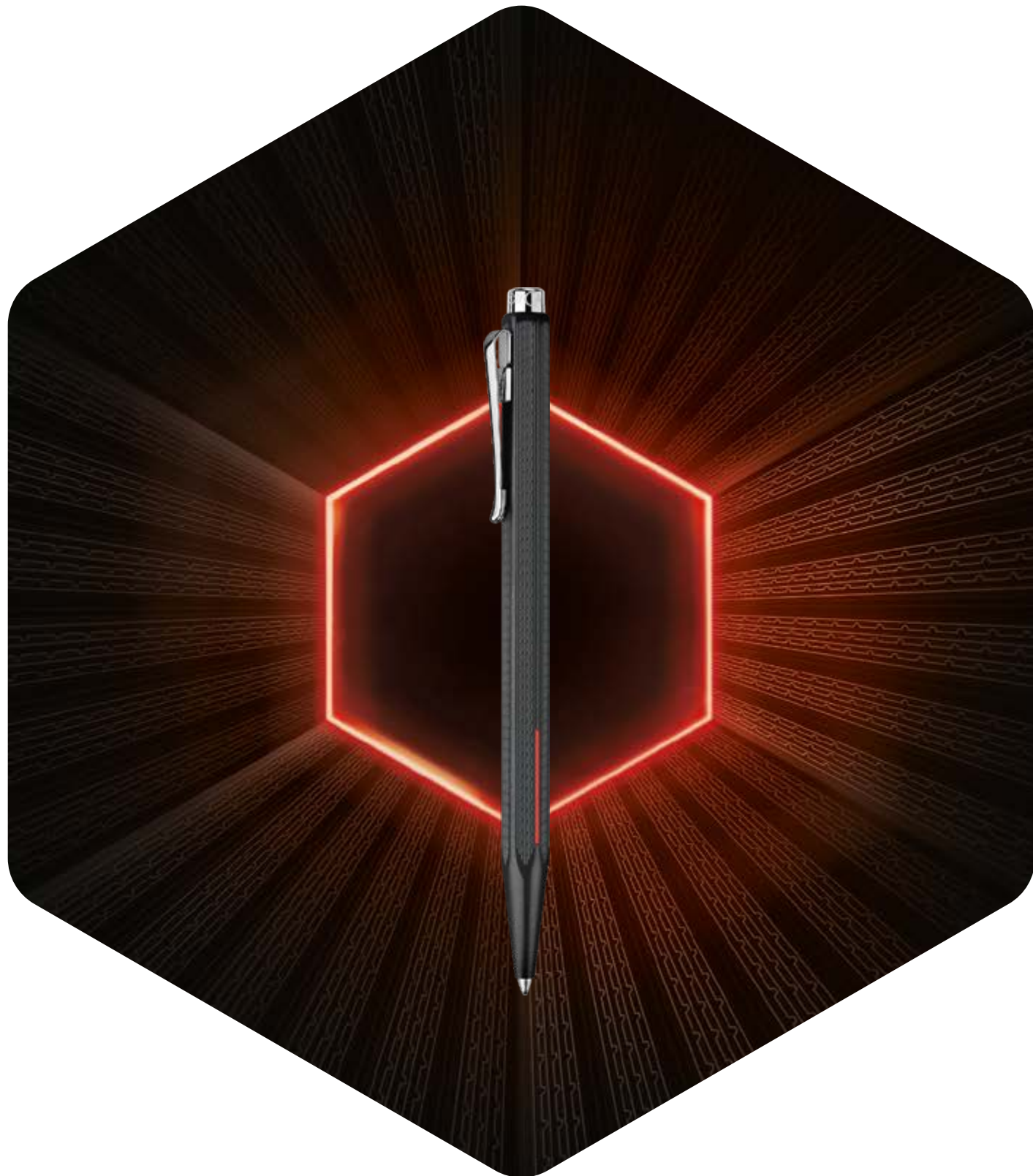

ECRIDOR RACING
MATT FINISH

BALLPOINT PEN / 890.009

Mechanism: Push button
Goliath refills: large, medium or fine (p.142)



ECRIDOR RACING
MATT FINISH

MECHANICAL PENCIL / 4.009

0.7 mm lead
Mechanism: Push button
Refills: 0.7 mm graphite leads, HB or B and replacement erasers (p.143)



THE CASE
ECRIDOR RACING

18,4 x 8 x 4 cm
Standard screen-printed case
Includes:
- the user guide / warranty
- a black Goliath M refill

**BALLPOINT PEN +
LEATHER GIFT BOX**
8902.009

Cardboard box with drawer, with removable red sleeve
Includes:
- black calfskin grained leather
- the user guide / warranty
- a black Goliath M refill



«SWISS ENGINEERING»

Caran d'Ache unveils the Ecridor Racing, the first writing instrument boasting a total black look from the eponymous collection. Inspired by the sleek designs seen in the world of motor racing, this resolutely contemporary ballpoint pen once again highlights the creative force of the century-old company.

The new Ecridor Racing asserts its motor racing genes: deep matt black body decorated with engravings inspired by radiator grilles, palladium-plated profile attributes, intense red flashes and even the engine that will keep running well beyond 600 pages of A4. Swiss Made from our designers' vision to production in the Swiss workshops, the Ecridor Racing is a series model with a strong, distinctive and resolutely masculine character. An ideal writing companion, this new pen will delight fans of objects that reflect their independent and dynamic spirit.



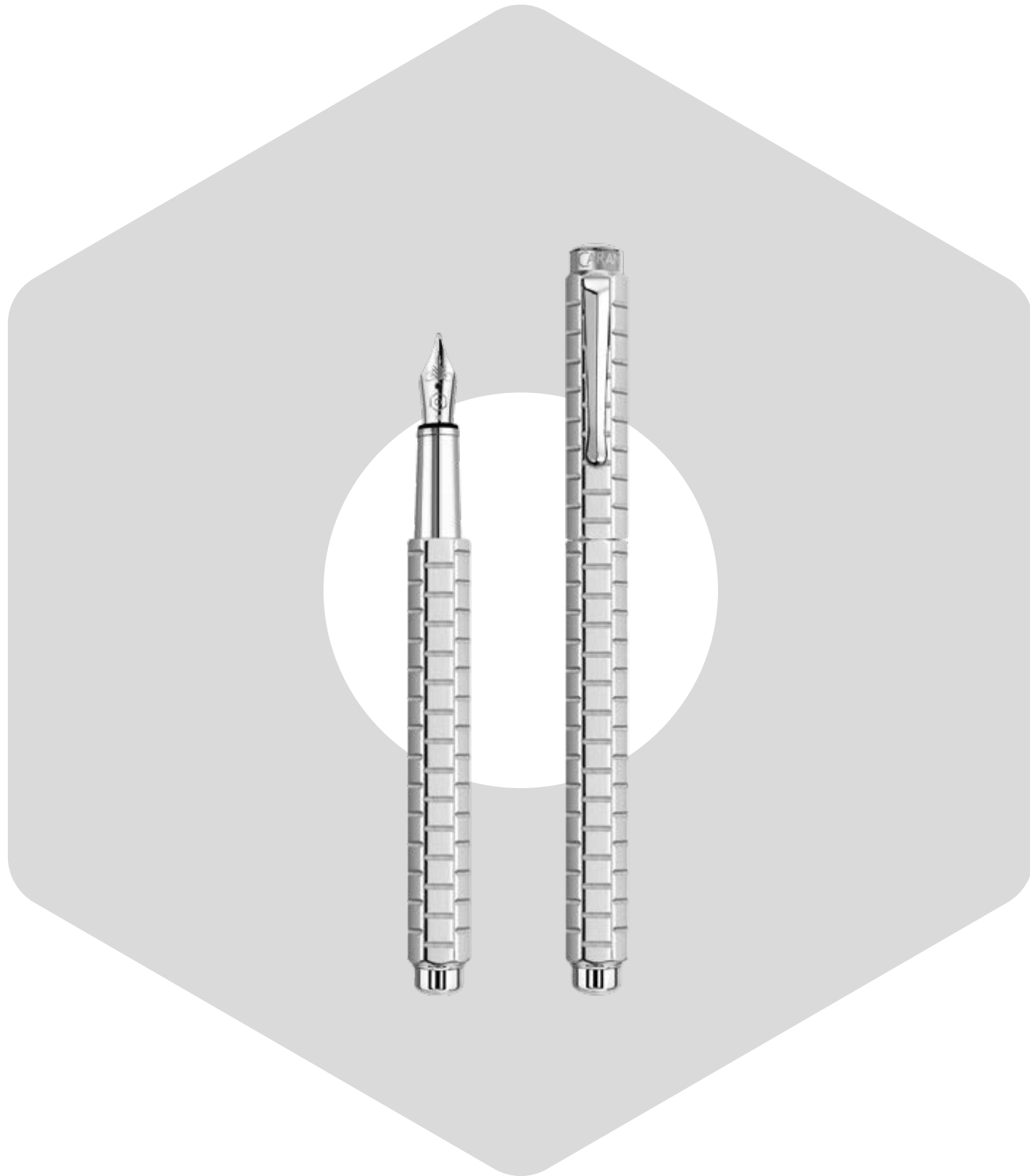

Caran d'Ache presents Ecridor Avenue, a new style for its iconic Ecridor Collection. Adorned with harmoniously-aligned engraved cubes, Ecridor Avenue celebrates the paving in Geneva's streets, highlighting a specific facet of the family firm's exceptional know-how. With Ecridor Avenue, Caran d'Ache invites aficionados of beautiful objects to take a stroll through the streets of Geneva. The city and its carefully aligned cobblestones have been transformed into a hundred polished quadrilaterals, which are delicately arranged and engraved on the body of the pen. This sophisticated edition features certain attributes which recall exceptional Swiss know-how in another field: watchmaking. The squares – so delicate to the touch and reflective of the light – are reminiscent of the links of a watch strap, paying homage to the mastery of precision mechanisms. This design and finesse lend Ecridor Avenue a resolutely urban and contemporary style while nevertheless respecting tradition.



ECRIDOR AVENUE

FOUNTAIN PEN / M - 958.407

Nib sizes: B -.417 / F -.397
 Nib: steel, rhodium-coated
 Cap: Click-in
 Piston ink pump or ink cartridge
 Refill: Ink and cartridges Chromatics Collection (p.136-141)



ECRIDOR AVENUE

ROLLERBALL PEN / M - 838.407

Cap: Click-in
 Refills: Rollerball fine tip, Fineliner fine or medium tip blue or black (p.142)



ECRIDOR AVENUE

BALLPOINT PEN / M - 890.407

Mechanism: Push button
 Goliath refills: large, medium or fine (p.142)



ECRIDOR AVENUE

MECHANICAL PENCIL / 4.407

0.7 mm lead
 Mechanism: Push button
 Refills: 0.7 mm graphite leads, HB or B and replacement erasers (p.143)



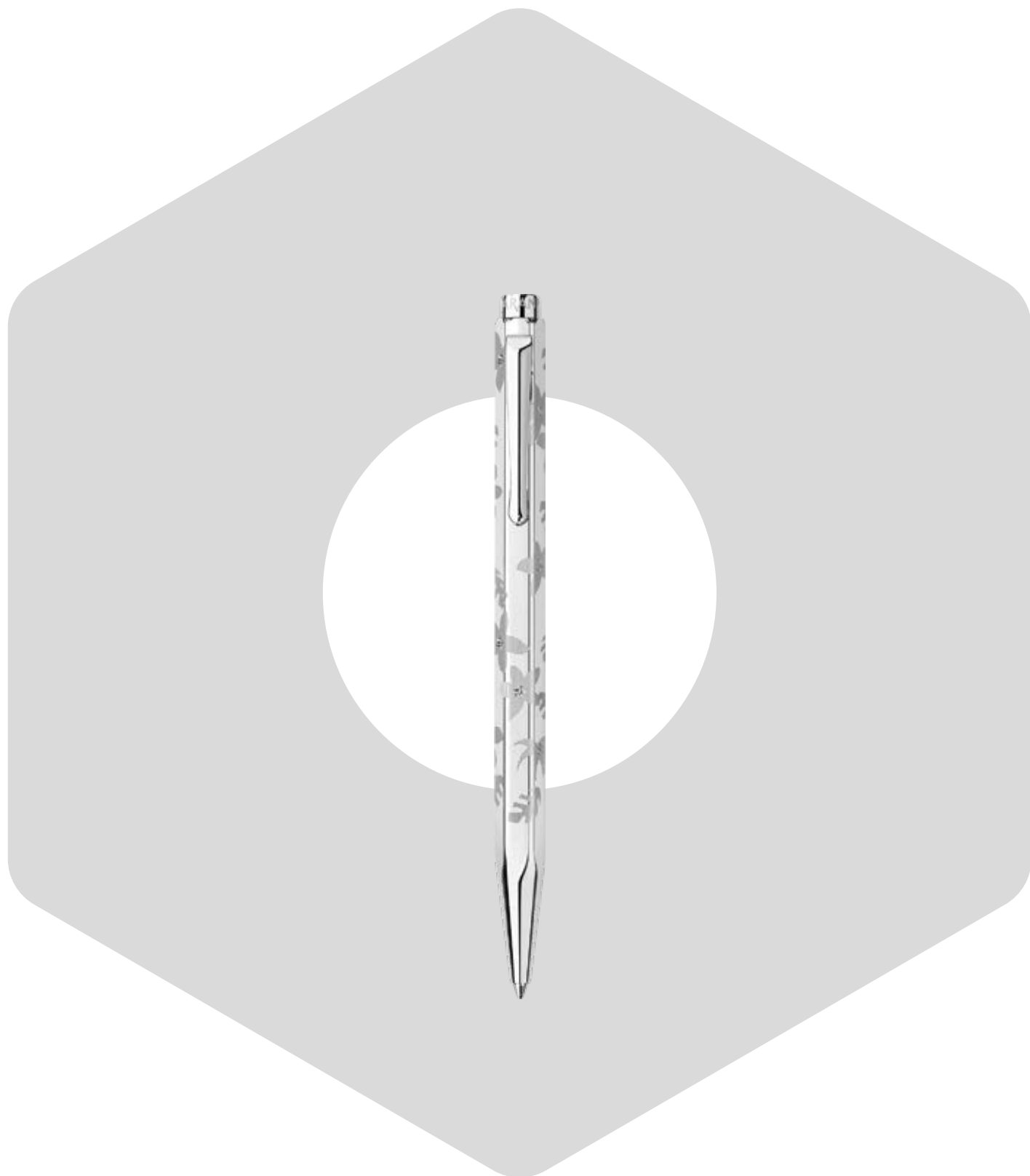

ECRIDOR FLOWERS

BALLPOINT PEN / 890.017

Mechanism: Push button
Goliath refills: large, medium or fine (p.142)



THE CASE
ECRIDOR FLOWERS

18,4 x 8 x 4 cm
Standard screen-printed case
Includes:
- the user guide / warranty
- a black Goliath M refill

The Maison Caran d'Ache presents Ecridor Flowers, inspired by the poetry of exotic gardens. Thanks to the expertise of artisans from the Swiss Manufacture, a luxuriant, heavenly natural environment places its radiant stamp on these emblematic Haute Écriture writing instruments. Since its creation in 1930, Ecridor by the Maison Caran d'Ache has celebrated the art of engraving on the hexagonal bodies of these iconic writing instruments. The master-craftsmen at the Geneva Manufacture apply their talent to unremittingly innovative techniques. The motifs displayed on the models in this emblematic collection reveal a series of universes that are inspiring, timeless, sophisticated and elegant. For the first time, Caran d'Ache combines two engraving techniques to create the plant motifs of which Ecridor Flowers is composed. Using a laser, the designs of leaves and petals are outlined with exceptional precision and delicate whiteness on the body of the ballpoint pen. The three different sizes of the stamens within the exotic flowers produce the radiance of precious stones.



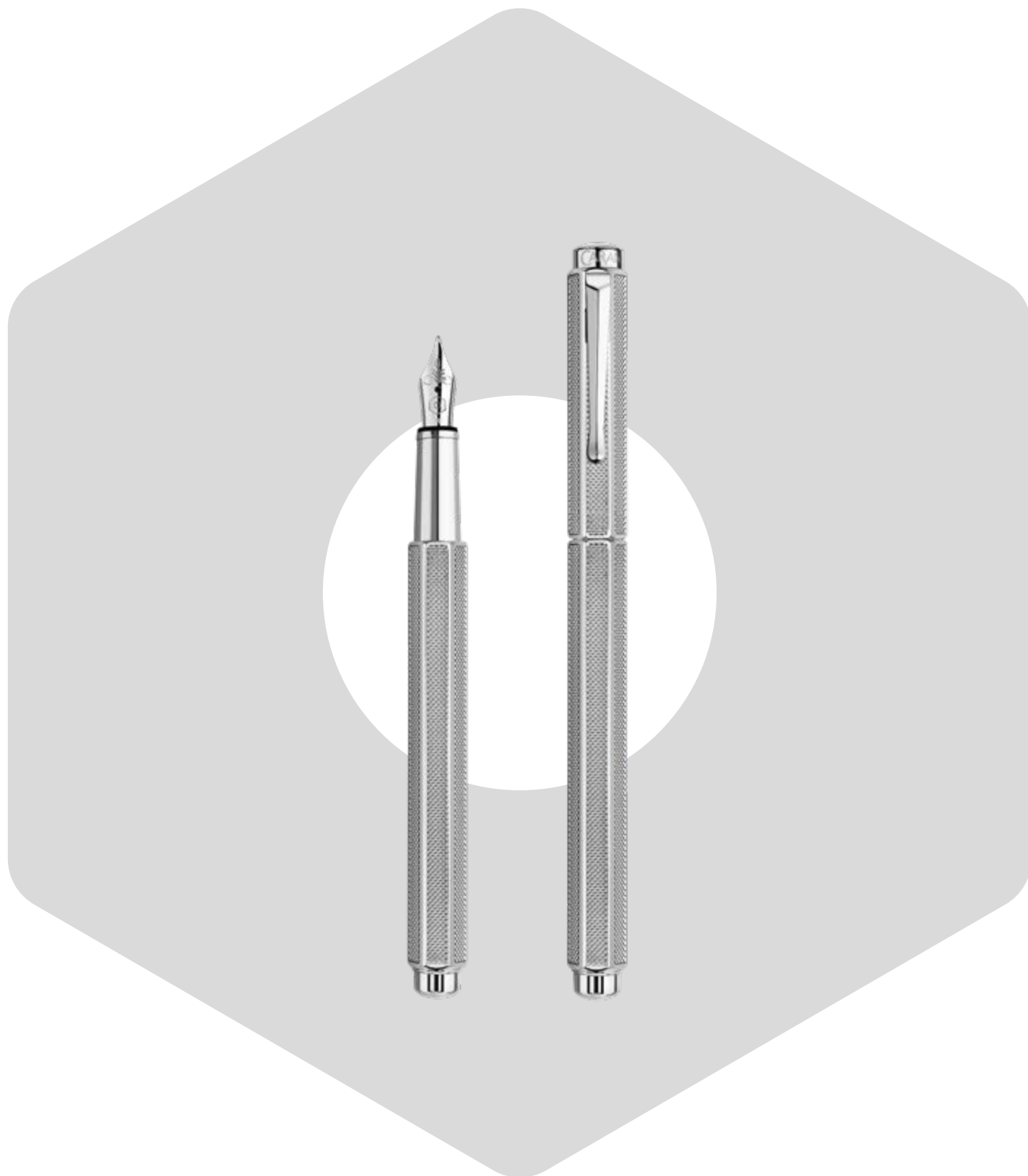

LE GUILLOCHAGE MAILLE MILANAISE

Popular in the watchmaking industry, the Milanese mesh embodies both a retro-chic style and a timeless elegance. The master craftsmen at Caran d'Ache have drawn inspiration from this pattern – created in the 17th century by Milanese goldsmiths – to lend the body of this iconic pen its own unique light. The refined lustre makes the Ecridor a highly exclusive accessory, echoing the aesthetics of fine watchmaking and leaving a lasting legacy.



ECRIDOR MAILLE MILANAISE

FOUNTAIN PEN / M - 958.345

Nib sizes: B - .355 / F - .335

Nib: steel, rhodium-coated

Cap: Click-in

Piston ink pump or ink cartridge

Refill: Ink and cartridges Chromatics Collection (p.136-141)



ECRIDOR MAILLE MILANAISE

ROLLER PEN / 838.345

Cap: Click-in

Refills: Rollerball fine tip, Fineliner fine or medium tip blue or black (p.142)



ECRIDOR MAILLE MILANAISE

BALLPOINT PEN / 890.345

Mechanism: Push button

Goliath refills: large, medium or fine (p.142)

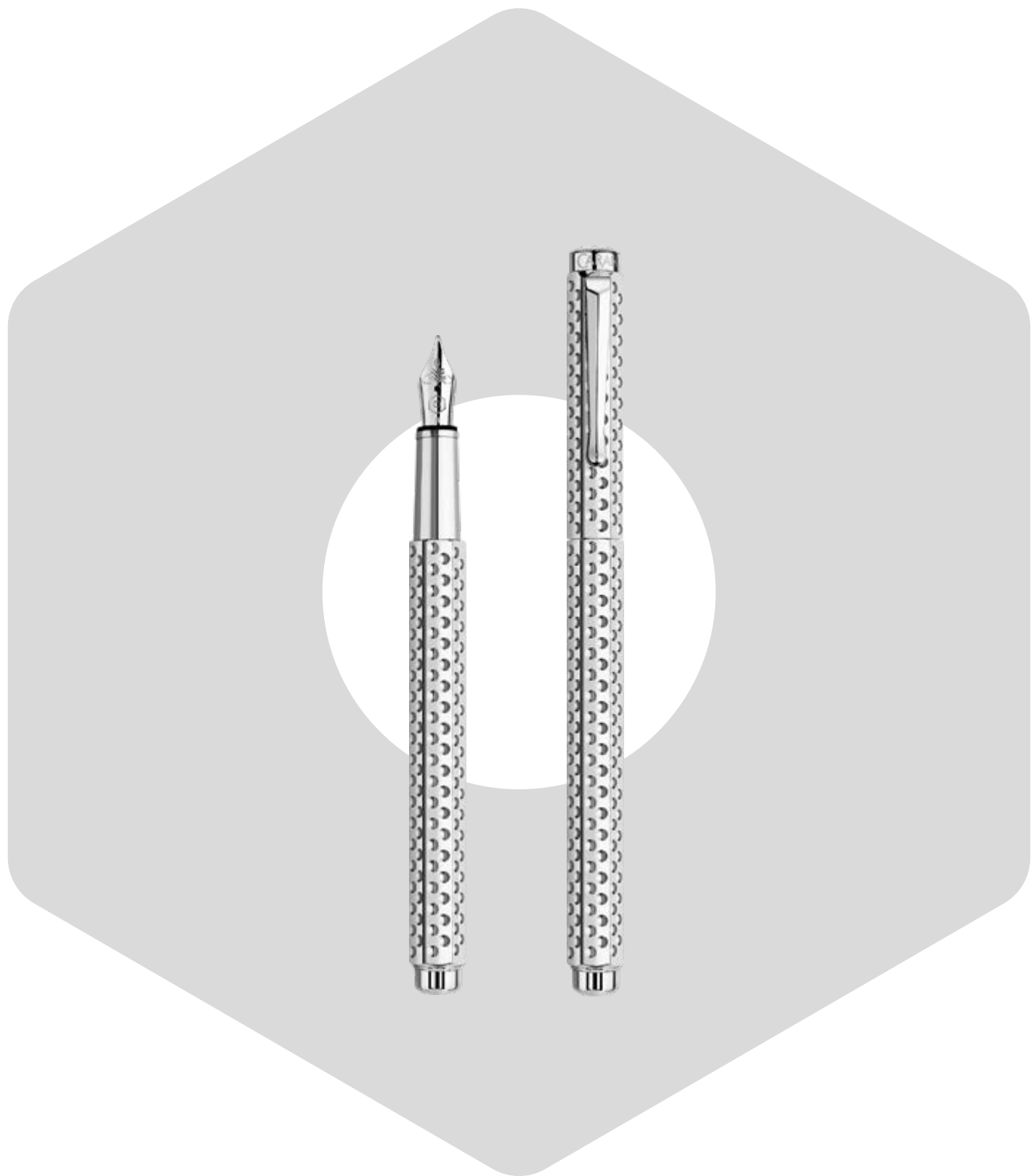

GOLF GUILLOCHE
 The Ecridor's unmistakable hexagonal body is decorated with an original geometric guilloché inspired by the dimples on a golf ball.



ECRIDOR GOLF | **FOUNTAIN PEN / M - 958.516**
 Nib sizes: B-.526 / F-.506
 Nib: steel, rhodium-coated
 Cap: Click-in
 Piston ink pump or ink cartridge
 Refill: Ink and cartridges Chromatics Collection (p.136-141)



ECRIDOR GOLF | **ROLLER PEN / 838.516**
 Cap: Click-in
 Refills: Rollerball fine tip, Fineliner fine or medium tip blue or black (p.142)



ECRIDOR GOLF | **BALLPOINT PEN / 890.516 / CL**890.526**
 Mechanism: Push button
 Goliath refills: large, medium or fine (p.142)



ECRIDOR GOLF | **MECHANICAL PENCIL / 4.516 / CL**4.526**
 0.7 mm lead
 Mechanism: Push button
 Refills: 0.7 mm graphite leads, HB or B and replacement erasers (p.143)

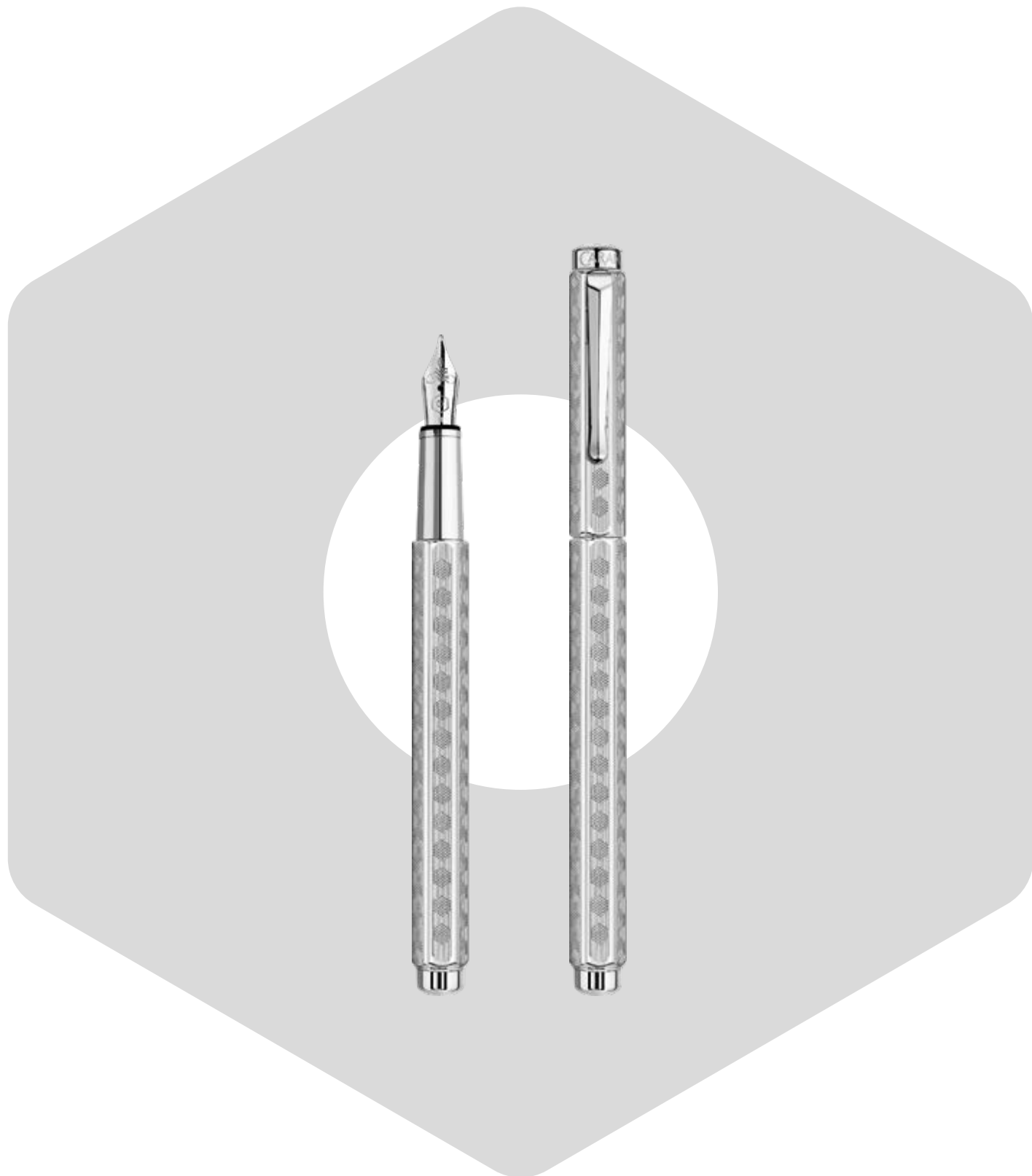

HERITAGE GUILLOCHE

The Ecridor Heritage is decorated with hexagons, a symbolic motif evoking the identity of the Geneva-based Maison. Like a kaleidoscope, the hexagon transforms into cubes revealing endless mirror perspective.



ECRIDOR HERITAGE

FOUNTAIN PEN / M-958.349

Nib sizes: B -.359 / F -.339
 Nib: steel, rhodium-coated
 Cap: Click-in
 Piston ink pump or ink cartridge
 Refill: Ink and cartridges Chromatics Collection (p.136-141)



ECRIDOR HERITAGE

ROLLER PEN / 838.349

Cap: Click-in
 Refills: Rollerball fine tip, Fineliner fine or medium tip blue or black (p.142)



ECRIDOR HERITAGE

BALLPOINT PEN / 890.349 / CL 890.359**

Mechanism: Push button
 Goliath refills: large, medium or fine (p.142)



ECRIDOR HERITAGE

MECHANICAL PENCIL / 4.349

0.7 mm lead
 Mechanism: Push button
 Refills: 0.7 mm graphite leads, HB or B and replacement erasers (p.143)



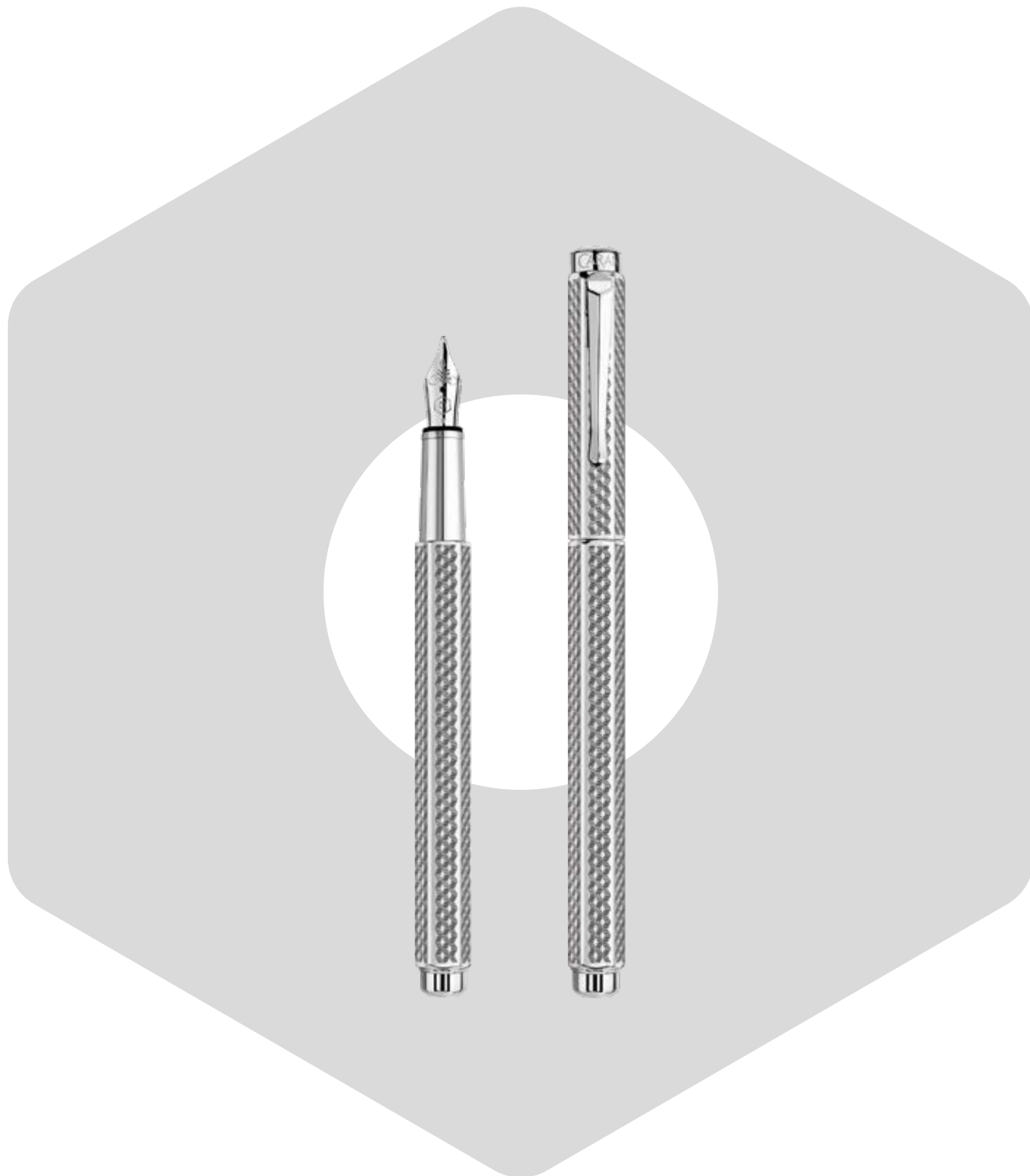

CUBRIK GUILLOCHE
 The six facets are decorated with guilloché geometric lines that reproduce endlessly to create a cascade of cubic shapes.



ECRIDOR CUBRIK

FOUNTAIN PEN / M-958.377

Nib sizes: B -.387 / F -.367
 Nib: steel, rhodium-coated
 Cap: Click-in
 Piston ink pump or ink cartridge
 Refill: Ink and cartridges Chromatics Collection (p.136-141)

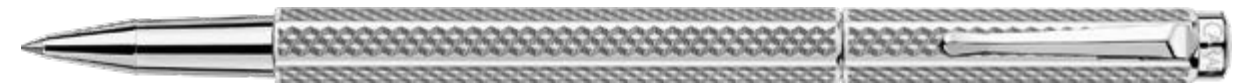

ECRIDOR CUBRIK

ROLLER PEN / 838.377

Cap: Click-in
 Refills: Rollerball fine tip, Fineliner fine or medium tip blue or black (p.142)

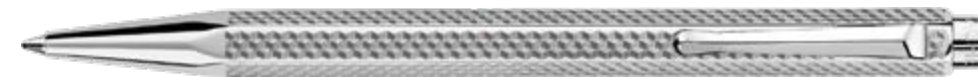

ECRIDOR CUBRIK

BALLPOINT PEN / 890.377 / CL 890.387**

Mechanism: Push button
 Goliath refills: large, medium or fine (p.142)

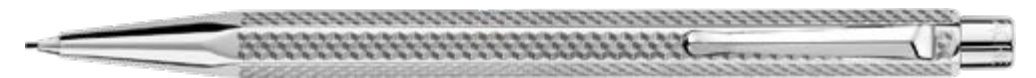

ECRIDOR CUBRIK

MECHANICAL PENCIL / 4.377

0.7 mm lead
 Mechanism: Push button
 Refills: 0.7 mm graphite leads, HB or B and replacement erasers (p.143)

ECRIDOR CHEVRON
GILDED FINISH

FOUNTAIN PEN / M-958.208

Nib sizes: B - .218 / F - .198
Nib: gilded steel
Cap: Click-in
Piston ink pump or ink cartridge
Refills: Ink and cartridges
Collection Chromatics (p.136-141)



ECRIDOR CHEVRON

FOUNTAIN PEN / M-958.286 / CL** M-958.287

Nib sizes: B - .296 / F - .276
CL: M-958.287 / B - .297 / F - .277
Nib: steel, rhodium-coated
Cap: Click-in
Piston ink pump or ink cartridge
Refill: Ink and cartridges Chromatics Collection (p.136-141)

CHEVRON GUILLOCHE

Inspired by a popular reversed v-shape design, the Chevron guilloche is engraved with the use of a diamond.



ECRIDOR CHEVRON
GILDED FINISH

ROLLER PEN / 838.208

Cap: Click-in
Refills: Rollerball fine tip, Fineliner fine or medium tip blue or black (p.142)

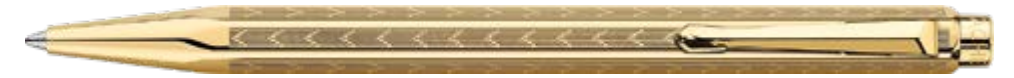

ECRIDOR CHEVRON
GILDED FINISH

BALLPOINT PEN / 898.208 / CL** 898.408

Mechanism: Push button
Goliath refills: large, medium or fine (p.142)



ECRIDOR CHEVRON
GILDED FINISH

MECHANICAL PENCIL / 4.208 / CL** 4.408

0.7 mm lead
Mechanism: Push button
Refills: 0.7 mm graphite leads, HB or B and replacement erasers (p.143)



ECRIDOR CHEVRON

ROLLER PEN / 838.286 / CL** 838.296

Cap: Click-in
Refills: Rollerball fine tip, Fineliner fine or medium tip blue or black (p.142)



ECRIDOR CHEVRON

BALLPOINT PEN / 890.286 / CL** 890.296

Mechanism: Push button
Goliath refills: large, medium or fine (p.142)



ECRIDOR CHEVRON

MECHANICAL PENCIL / 4.286 / CL** 4.276

0.7 mm lead
Mechanism: Push button
Refills: 0.7 mm graphite leads, HB or B and replacement erasers (p.143)



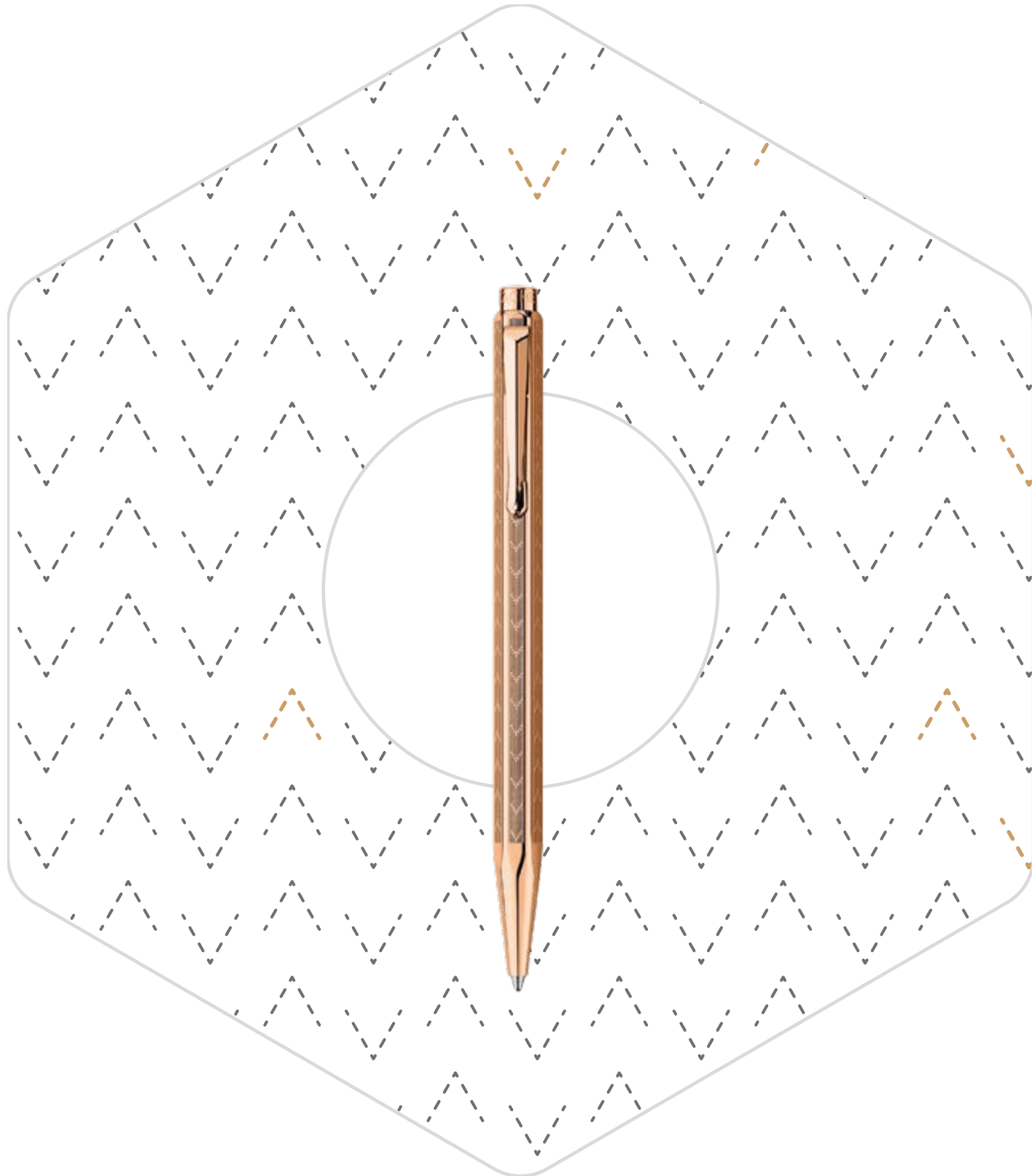

ECRIDOR CHEVRON ROSE-GILDED
ROSE-GILDED FINISH

BALLPOINT PEN / 898.207 / CL **898.407

Mechanism: Push button
Goliath refills: large, medium or fine (p.142)



THE CASE
ECRIDOR CHEVRON ROSE-GILDED

18,4 x 8 x 4 cm
Standard screen-printed case
Includes:
- the user guide / warranty
- a black Goliath M refill

The Ecridor Chevron collection is adorned with a new rose-gilded finish. It reveals all the brilliance of rose gold to become a new timeless icon of elegance for women.



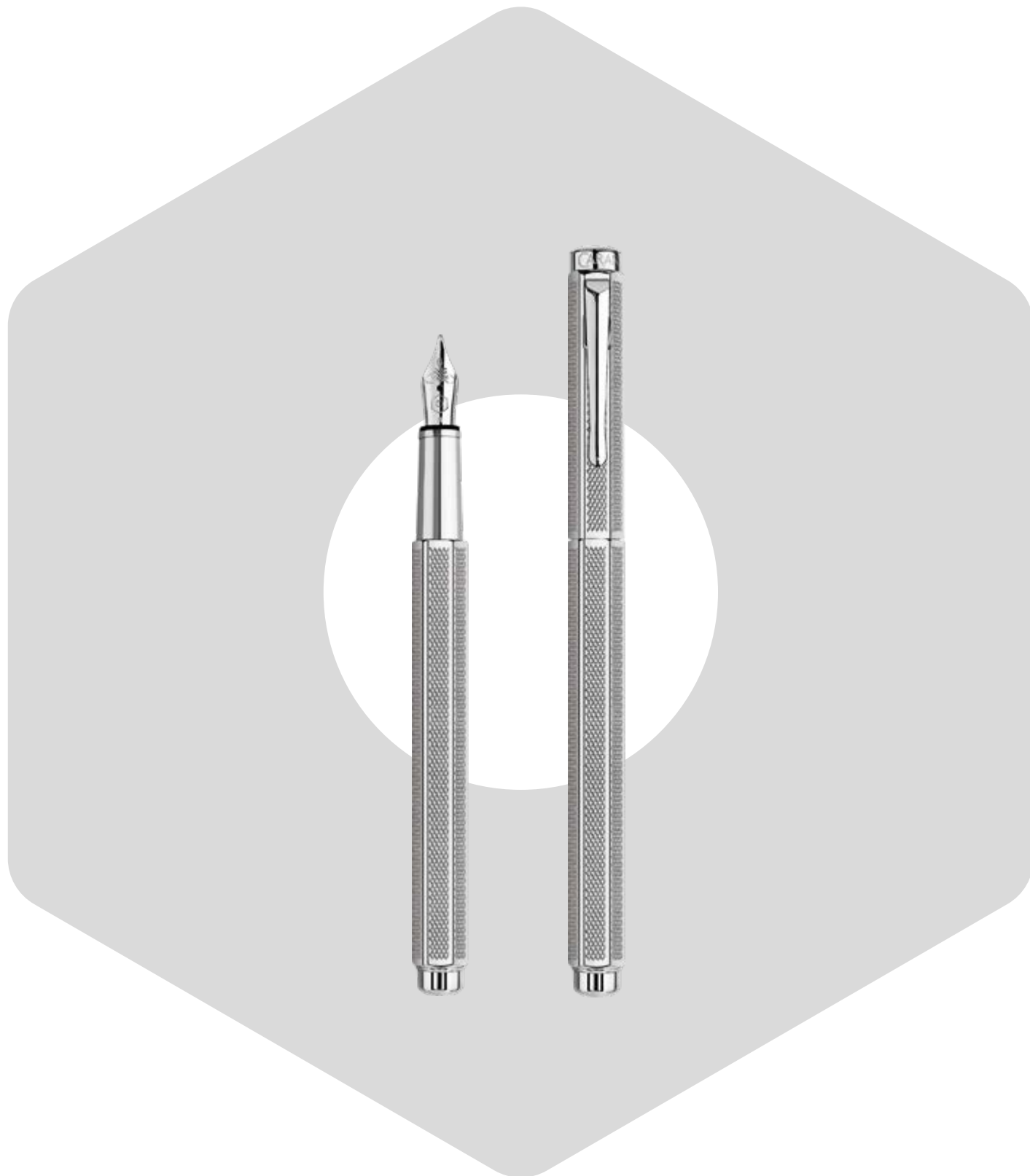

RETRO GUILLOCHE

Retro Guilloche is characterized by a lozenge decoration taken from the 1930s mechanical pencils, the first to be produced by the company with precious metals such as gold and silver.

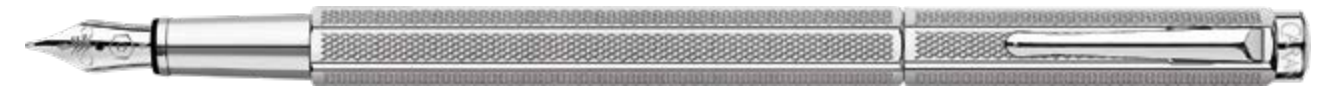

ECRIDOR RETRO

FOUNTAIN PEN / M-958.485 / CL** 958.486

Nib sizes: B -.495 / F -.475
 CL: M-958.486 / B -.496 / F -.476
 Nib: steel, rhodium-coated
 Cap: Click-in
 Piston ink pump or ink cartridge
 Refill: Ink and cartridges Chromatics Collection (p.136-141)

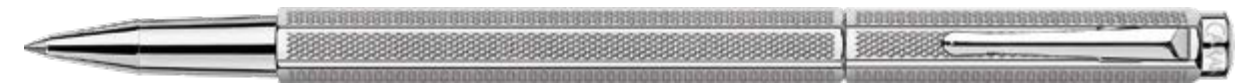

ECRIDOR RETRO

ROLLER PEN / 838.485 / CL** 838.495

Cap: Click-in
 Refills: Rollerball fine tip, Fineliner fine or medium tip blue or black (p.142)



ECRIDOR RETRO

BALLPOINT PEN / 890.487 / CL** 890.497

Mechanism: Push button
 Goliath refills: large, medium or fine (p.142)

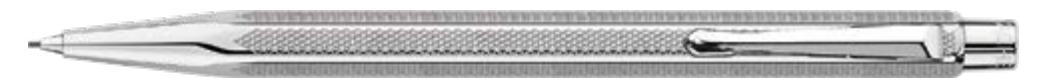

ECRIDOR RETRO

MECHANICAL PENCIL / 4.486 / CL** 4.496

0.7 mm lead
 Mechanism: Push button
 Refills: 0.7 mm graphite leads, HB or B and replacement erasers (p.143)





LES CRAYONS DE LA MAISON

Caran d'Ache craftsmen regularly introduce new noble materials to create original limited collections of pencils. These exclusive collections invite you to discover species from new countries.

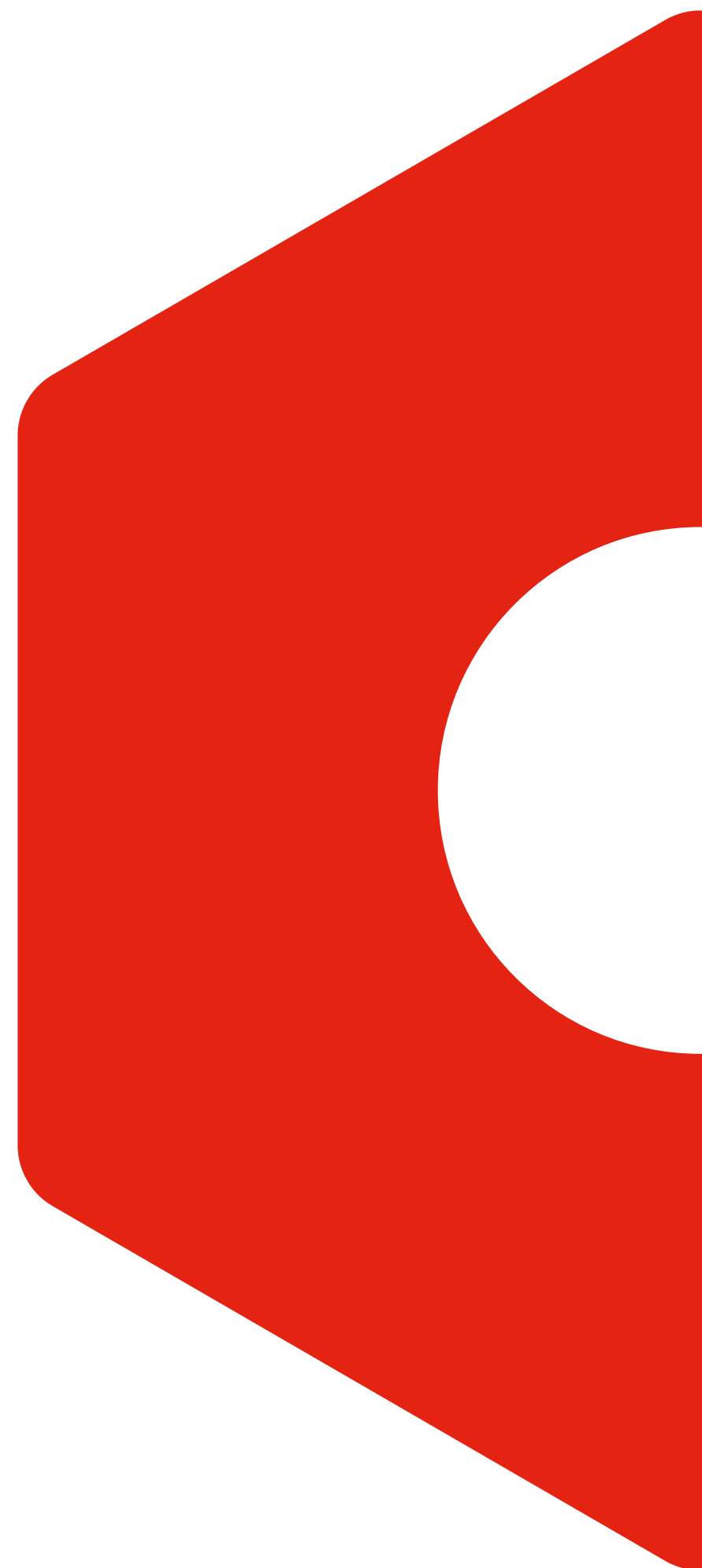



CARAN D'ACHE

Genève

+

MIZENSIR



* As wood species may change, the visuals of the pencils are not definitive.

LES CRAYONS DE LA MAISON
EDITION N°10 – LIMITED EDITION

GRAPHITE PENCILS / 361.414
4 HB graphite pencils
Wooden pencils
Perfume: "Bois de Patchouli"

DISPLAY
EDITION N°10 – LIMITED EDITION

Cardboard display delivered with 4 NOT FOR SALE pencils. Contains up to 5 packs of pencils. The display is supplied empty – no pencil sets included. Dimensions: 160 x 100 x 225 mm. Reference: 100017.143

In this latest edition, Caran d'Ache presents scented pencils in partnership with Geneva perfume-maker, Mizensir, which specialises in home fragrances and candles. The "Bois de Patchouli" fragrance, selected by Caran d'Ache, reveals the mystery of patchouli combined with cedar wood and gaïac wood, coated with a sweetness of burnt caramel.





LIMITED EDITIONS





HOMMAGE

LIMITED EDITIONS



十二生肖

CHINESE ZODIAC

Caran d'Ache pays homage to the fine arts through its "Chinese calendar" collection, designed to bring the legend of the symbols of the Chinese zodiac to life. According to legend, the Jade Emperor invited all the animals to a mysterious gathering on New Year's Eve. He wanted to organise a race between the different species to establish a hierarchy among the animals. Only twelve animals accepted the invitation. The Emperor then gave each animal a unique gift: henceforth, a year would be dedicated to them and would bear their name. This is how the order of the animal signs of the Chinese zodiac was established.

1. The Rat - 鼠
2. The Ox - 牛
3. The Tiger - 虎
4. The Hare - 兔
5. The Dragon - 龍
6. The Snake - 蛇
7. The Horse - 馬
8. The Goat - 羊
9. The Monkey - 猴
10. The Rooster - 雞
11. The Dog - 狗
12. The Pig - 猪



With its "Chinese Calendar" collection, Caran d'Ache brings the legend of the symbols of the Chinese zodiac to life. The "Year of the Tiger" limited edition carries on the tradition of this collection of exceptional writing instruments to celebrate the advent of the Chinese Year of the Tiger. The elegant shape of the tiger appears against a background of black gloss Chinese lacquer, meticulously applied layer by layer using techniques handed down through generations. The lines and curves of its body are enhanced in genuine orange Chinese lacquer. The Chinese seal in Caran d'Ache red and the gilt attributes create a striking contrast with this dark material, emphasising the meticulous work of the master lacquerer.



THE YEAR OF THE TIGER

The third animal in the Chinese zodiacal cycle, the tiger symbolises boldness, power and seduction. The epitome of daring, the tiger will foster courage and determination throughout the year. The "Year of the Tiger" writing instruments are designed and created as an artistic tribute. They embody the precious arts of engraving and authentic Chinese lacquer, long cultivated in the Caran d'Ache workshops.

CHINESE LACQUER

Known since the 14th century BCE, the art of Chinese lacquer was developed during the reign of the Shang dynasty. The natural material comes from the sap of the "Rhus Vernicifera" tree, which is native to tropical Asia. Produced entirely by hand, the meticulous application of successive thin layers of lacquer requires unfailing patience. The hand polishing reveals its incomparable hues.

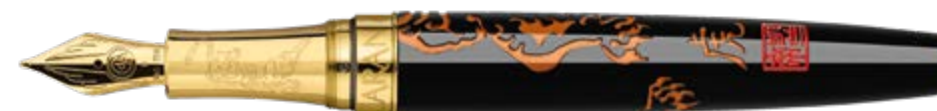

YEAR OF THE TIGER
GOLD-PLATED FINISH

FOUNTAIN PEN / M nib: 5092.058 (other nib widths available on request)

Nib: 18-carat yellow gold
Refills: Chromatics collection ink and cartridges (p.136-141)



YEAR OF THE TIGER
GOLD-PLATED FINISH

ROLLER PEN / 5072.058

Refills: rollerball, fineliner fine tip or medium tip, blue or black (p.142)

THE CASE
YEAR OF THE TIGER

19.5 x 10.2 x 6.8 cm
Made from screen-printed, brilliant black-lacquered wood
The inner wedge is reversible and can house 1 or 2 pens
The Year of the Tiger limited edition is delivered with:
- its user guide / warranty
- two blue ink cartridges or one black Rollerball fine tip refill
- the certificate of authenticity of the Chinese lacquer
- the edition brochure



THE BROCHURE
YEAR OF THE TIGER

14 x 20 cm
8 interior pages
Bilingual brochure: EN / CN
Reference: 100017.791

ASE INCLUDING
12 GREETING CARDS

14.8 x 21 cm
Tribute to the 12 signs of the Chinese zodiac
Designed by the calligrapher Lam Chi Van
Reference: 100015.280





YEAR OF THE OX
GOLD-PLATED FINISH

FOUNTAIN PEN / M nib: 5092.057 (other nib widths available on request)

Nib: 18-carat yellow gold
Refills: Chromatics collection ink and cartridges (p.136-141)



YEAR OF THE OX
GOLD-PLATED FINISH

ROLLER PEN / 5072.057

Refills: rollerball, fineliner fine tip or medium tip, blue or black (p.142)

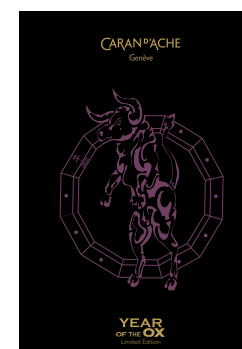

THE BROCHURE
YEAR OF THE OX

14 x 20 cm
8 interior pages
Bilingual brochure: EN / CN
Reference: 100017.362





YEAR OF THE RAT
GOLD-PLATED FINISH

FOUNTAIN PEN / M nib: 5092.056 (other nib widths available on request)
Nib: 18-carat yellow gold
Refills: Chromatics collection ink and cartridges (p.136-141)



YEAR OF THE PIG
GOLD-PLATED FINISH

FOUNTAIN PEN / M nib: 5092.055 (other nib widths available on request)
Nib: 18-carat yellow gold
Refills: Chromatics collection ink and cartridges (p.136-141)



YEAR OF THE DOG
GOLD-PLATED FINISH

FOUNTAIN PEN / M nib: 5092.054 (other nib widths available on request)
Nib: 18-carat yellow gold
Refills: Chromatics collection ink and cartridges (p.136-141)



YEAR OF THE RAT
GOLD-PLATED FINISH

ROLLER PEN / 5072.056
Refills: rollerball, fineliner fine tip or medium tip, blue or black (p.142)



YEAR OF THE PIG
GOLD-PLATED FINISH

ROLLER PEN / 5072.055
Refills: rollerball, fineliner fine tip or medium tip, blue or black (p.142)



YEAR OF THE DOG
GOLD-PLATED FINISH

ROLLER PEN / 5072.054
Refills: rollerball, fineliner fine tip or medium tip, blue or black (p.142)



THE BROCHURE
YEAR OF THE RAT

14 x 20 cm
8 interior pages
Bilingual brochure: EN / CN
Reference: 100016.827

THE BROCHURE
YEAR OF THE PIG

14 x 20 cm
8 interior pages
Bilingual brochure: EN / CN
Reference: 100016.588



THE BROCHURE
YEAR OF THE DOG

14 x 20 cm
8 interior pages
Bilingual brochure: EN / CN
Reference: 100016.173





YEAR OF THE ROOSTER
GOLD-PLATED FINISH

FOUNTAIN PEN / M nib: 5092.053 (other nib widths available on request)
Nib: 18-carat yellow gold
Refills: Ink and cartridges Chromatics Collection (p.136-141)



YEAR OF THE MONKEY
GOLD-PLATED FINISH

FOUNTAIN PEN / M nib: 5092.052 (other nib widths available on request)
Nib: 18-carat yellow gold
Refills: Ink and cartridges Chromatics Collection (p.136-141)



YEAR OF THE GOAT
GOLD-PLATED FINISH

FOUNTAIN PEN / M nib: 5092.051 (other nib widths available on request)
Nib: 18-carat yellow gold
Refills: Ink and cartridges Chromatics Collection (p.136-141)



YEAR OF THE ROOSTER
GOLD-PLATED FINISH

ROLLER PEN / 5072.053
Refills: Rollerball fine tip, Fineliner fine or medium tip blue or black (p.142)



YEAR OF THE MONKEY
GOLD-PLATED FINISH

ROLLER PEN / 5072.052
Refills: Rollerball fine tip, Fineliner fine or medium tip blue or black (p.142)



YEAR OF THE GOAT
GOLD-PLATED FINISH

ROLLER PEN / 5072.051
Refills: Rollerball fine tip, Fineliner fine or medium tip blue or black (p.142)

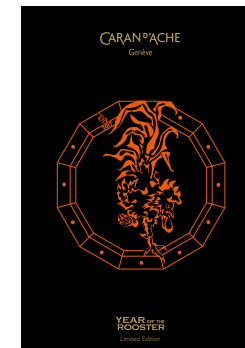

THE BROCHURE
YEAR OF THE ROOSTER

14 x 20 cm
8 interior pages
Bilingual brochure: EN / CN
Available in digital version only

THE BROCHURE
YEAR OF THE MONKEY

14 x 20 cm
8 interior pages
Bilingual brochure: EN / CN
Available in digital version only



THE BROCHURE
YEAR OF THE GOAT

14 x 20 cm
8 interior pages
Bilingual brochure: EN / CN
Available in digital version only





YEAR OF THE HORSE
GOLD-PLATED FINISH

FOUNTAIN PEN / M nib: 5092.050 (other nib widths available on request)
Nib: 18-carat yellow gold
Refills: Ink and cartridges Chromatics Collection (p.136-141)



YEAR OF THE SNAKE
GOLD-PLATED FINISH

FOUNTAIN PEN / M nib: 5092.037 (other nib widths available on request)
Nib: 18-carat yellow gold
Refills: Ink and cartridges Chromatics Collection (p.136-141)



YEAR OF THE DRAGON
GOLD-PLATED FINISH

FOUNTAIN PEN / M nib: 5092.036 (other nib widths available on request)
Nib: 18-carat yellow gold
Refills: Ink and cartridges Chromatics Collection (p.136-141)



YEAR OF THE HORSE
GOLD-PLATED FINISH

ROLLER PEN / 5072.050
Refills: Rollerball fine tip, Fineliner fine or medium tip blue or black (p.142)



YEAR OF THE SNAKE
GOLD-PLATED FINISH

ROLLER PEN / 5072.037
Refills: Rollerball fine tip, Fineliner fine or medium tip blue or black (p.142)



YEAR OF THE DRAGON
GOLD-PLATED FINISH

ROLLER PEN / 5072.036
Refills: Rollerball fine tip, Fineliner fine or medium tip blue or black (p.142)



THE BROCHURE
YEAR OF THE HORSE

14 x 20 cm
8 interior pages
Bilingual brochure: EN / CN
Available in digital version only

THE BROCHURE
YEAR OF THE SNAKE

14 x 20 cm
8 interior pages
Bilingual brochure: EN / CN
Available in digital version only

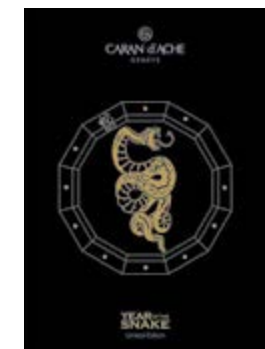

THE BROCHURE
YEAR OF THE DRAGON

14 x 20 cm
8 interior pages
Bilingual brochure: EN / CN
Available in digital version only





SPIRIT OF SWITZERLAND

To mark its 100th anniversary, Caran d'Ache paid tribute to its country with a limited edition of writing instruments, Spirit of Switzerland. This symbolic creation presents 14 elements of Swiss cultural identity.

Located at the heart of Europe and home to the snow-capped peaks of the Alps and the Jura, Switzerland enjoys international renown through its exceptional know-how, its iconic products, its idyllic countryside and its humanistic spirit. Swiss culture is characterised by its rich heritage, the incredible beauty of its natural landscapes and the unrelenting quest for perfection and quality in all areas of life.

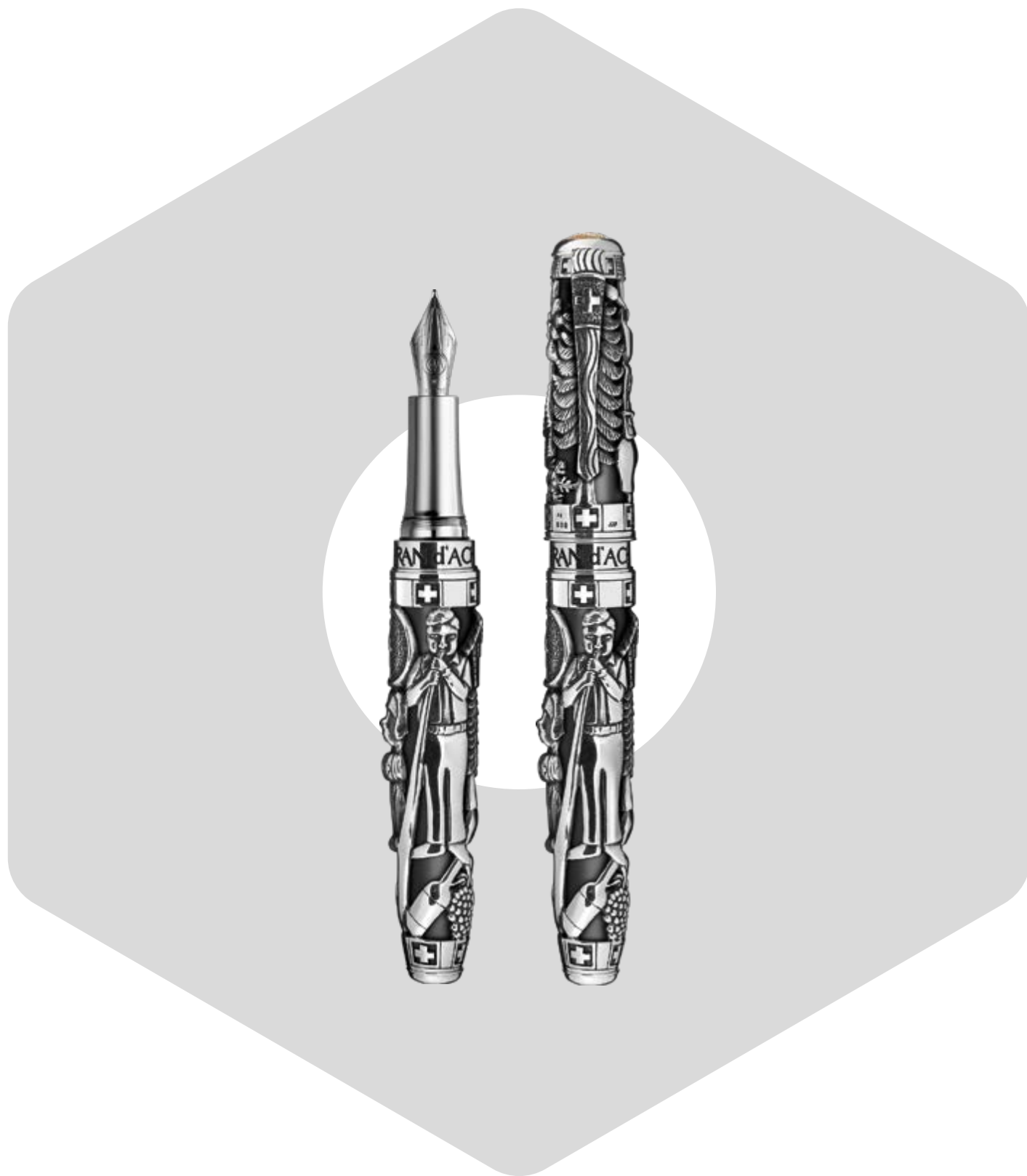

SPIRIT OF SWITZERLAND
SOLID SILVER FINISH

FOUNTAIN PEN / M nib: 5090.051 (other nib widths available on request)
Nib: 18-carat gold, rhodium-coated
Refills: Ink and cartridges Chromatics Collection (p.136-141)



SPIRIT OF SWITZERLAND
SOLID SILVER FINISH

ROLLER PEN / 5070.051
Refills: Rollerball fine tip, Fineliner fine or medium tip blue or black (p.142)

THE CASE
SPIRIT OF SWITZERLAND

22.3 x 16.3 x 9 cm
Made from screen-printed brilliant grey-lacquered wood
The inner wedge is reversible and can house 1 or 2 pens
The Spirit of Switzerland limited edition is delivered with:
- its user guide / warranty
- two blue ink cartridges or one black Rollerball fine tip refill
or a black M Goliath refill

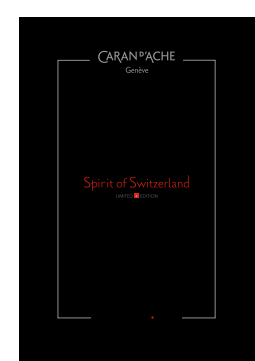

THE BROCHURE
SPIRIT OF SWITZERLAND

14 x 20 cm
8 interior pages
Brochure available in 3 languages
(FR, EN, DE)
Available in digital
version only

The limited edition dedicated to Switzerland featuring 14 figurative representations, emblematic of Swiss cultural identity. The figures appearing in relief, sculpted in solid silver and adorning the body of the pens, represent the emblematic sectors that make Switzerland and its cultural heritage shine across the world. The delicately carved figurative structure appears superimposed on the matt black lacquer body of the fountain and roller pens. Friezes engraved with Swiss crosses form delicate borders at the far ends of each part of the writing instrument. The Spirit of Switzerland limited edition consists of 100 numbered fountain and roller pens, in symbolic tribute to the 100th anniversary of the Maison Caran d'Ache.



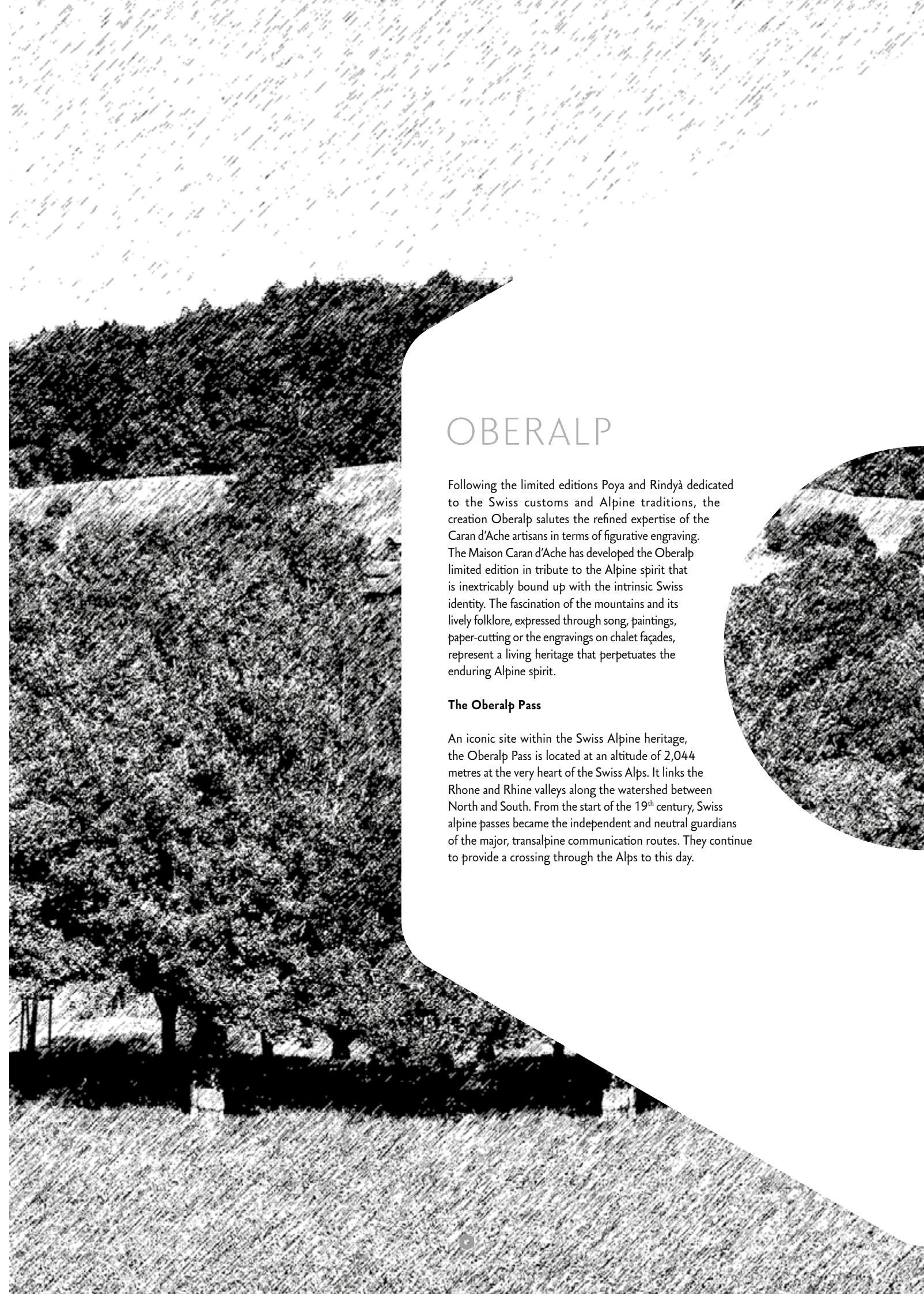

OBERALP

Following the limited editions Poya and Rindya dedicated to the Swiss customs and Alpine traditions, the creation Oberalp salutes the refined expertise of the Caran d'Ache artisans in terms of figurative engraving. The Maison Caran d'Ache has developed the Oberalp limited edition in tribute to the Alpine spirit that is inextricably bound up with the intrinsic Swiss identity. The fascination of the mountains and its lively folklore, expressed through song, paintings, paper-cutting or the engravings on chalet façades, represent a living heritage that perpetuates the enduring Alpine spirit.

The Oberalp Pass

An iconic site within the Swiss Alpine heritage, the Oberalp Pass is located at an altitude of 2,044 metres at the very heart of the Swiss Alps. It links the Rhone and Rhine valleys along the watershed between North and South. From the start of the 19th century, Swiss alpine passes became the independent and neutral guardians of the major, transalpine communication routes. They continue to provide a crossing through the Alps to this day.

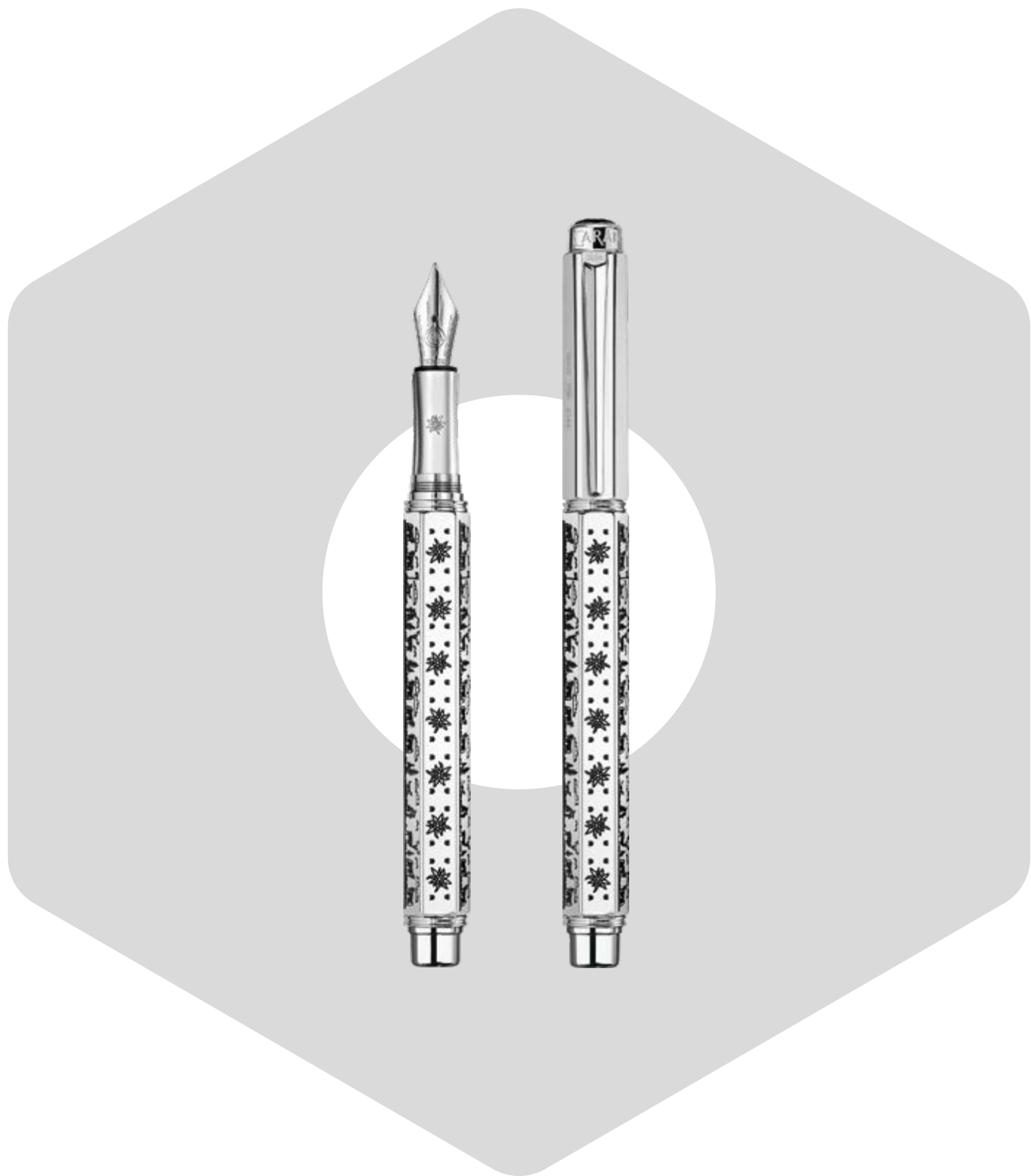

The Oberalp limited edition is dedicated to the mountain and Alpine spirit. A narrative frieze motif evokes the symbols of Alpine life and the idyllic scenery of the Swiss mountains. A second frieze, engraved on the other three sides of the pen, portrays the beauty of edelweiss flowers. Crafting these miniature frieze motifs reflects the finesse of the traditional Alpine art of paper- or wood-cutting. Each item is decorated with black lacquer applied entirely by hand. The body of the fountain pens and roller pens features the finely engraved outlines of three edelweiss blossoms. Paying symbolic homage to the highest point of the Oberalp Pass, Oberalp writing instruments are issued in a numbered series of 2,044.



OBERALP
SILVER-PLATED,
RHODIUM-COATED FINISH

FOUNTAIN PEN / M nib: 1651.481 (other nib widths available on request)

Nib: 18-carat gold, rhodium-coated
Refills: Ink and cartridges Chromatics Collection (p.136-141)



OBERALP
SILVER-PLATED,
RHODIUM-COATED FINISH

ROLLER PEN / 1661.481

Refills: Rollerball fine tip, Fineliner fine or medium tip blue or black (p.142)



OBERALP
SILVER-PLATED,
RHODIUM-COATED FINISH

BALLPOINT PEN / 1671.481

Goliath refills: large, medium or fine (p.142)



THE CASE
OBERALP

22.5 x 11 x 11 cm
Made from solid beech sourced in Switzerland.
Its shape reflects the design of a high alpine chalet and the edition's frieze is engraved onto the case.
The inner wedge is reversible and can house 1 or 2 pens
The Oberlap limited edition is delivered with:
- its user guide / warranty
- two blue ink cartridges or one black Rollerball fine tip refill or a black M Goliath refill

THE BROCHURE
OBERALP

24.5 x 10.7 cm
12 interior pages
Brochure available in 3 languages
References:
FR: 100014.949
EN: 100014.950
DE: 100014.951





SPECIAL
LIMITED EDITIONS





VARIUS PETER MARINO

Caran d'Ache unveiled two exceptional creations, Varius Peter Marino and Varius Peter Marino - Special Edition, dreamed up by the famous American architect, talented designer and lover of fine materials. The Varius writing instruments by Caran d'Ache are an intrinsic part of the designer's life. He has always used them to draw his magnificent buildings.

Caran d'Ache's iconic collection

Varius is the result of the passionate work with materials. The artisans exalts the noblest materials such as Chinese lacquer, carbon fibre, chain mail or ebony wood on the body of these fine creations. Precision, expertise and elegance are the hallmarks of this collection with superb writing comfort.

The two Varius Peter Marino versions are covered with leather, which provides unrivalled comfort. The architect's rock 'n' roll world fuses with the spirit of Varius writing instruments to ink two creations, which are simultaneously modern, surprising and fashionable. The essential values of the Varius collection are nonetheless safeguarded. Original materials do full justice to a custom-made approach, and ancestral skills are applied to create high-end models.



The Varius Peter Marino - Special Edition, designed by the architect, reflects his unique personality. The daring attributes of these instruments, symbolising strength according to Peter Marino, are interpreted by Caran d'Ache with good taste and expertise. A hand-made lacing goes through rhodium and silver-coated eyelets. The cap is topped by a silver-plated, rhodium-coated skull with black onyx eyes, reminiscent of the many rings adorning Peter Marino's fingers.

The bodies of the writing instruments are sheathed in French calfskin. Boasting a highly natural appearance, this elegant leather is used by the leading luxury leather goods boutiques. The patina of the leather will appear with time and use, giving it an authentic look.

A generic numbering system, 1/148 (one out of 148), evokes the address of the architect's Manhattan studio: 148 East 58 Street.

This is engraved on the cap at a scale of 1/148 along with Peter Marino's handwritten signature.



**VARIUS PETER MARINO
SPECIAL EDITION**
SILVER-PLATED,
RHODIUM-COATED FINISH

FOUNTAIN PEN / M - 1653.491 (other nib widths available on request)

Nib: 18-carat gold, rhodium-coated
Refills: Ink and cartridges Chromatics Collection (p.136-141)



**VARIUS PETER MARINO
SPECIAL EDITION**
SILVER-PLATED,
RHODIUM-COATED FINISH

ROLLER PEN / 1653.471

Refills: Rollerball fine tip, Fineliner fine or medium tip blue or black (p.142)



THE CASE
VARIUS PETER MARINO
SPECIAL EDITION

19.5 x 10.2 x 6.8 cm
Made using wood entirely sheathed in imitation leather and fine black stitching. The whole is screen-printed.
The inner wedge is specifically designed to hold the instrument.
The Peter Marino Varius special edition is delivered with:
- its user guide / warranty
- two blue ink cartridges or one black Rollerball fine tip refill
- the edition brochure

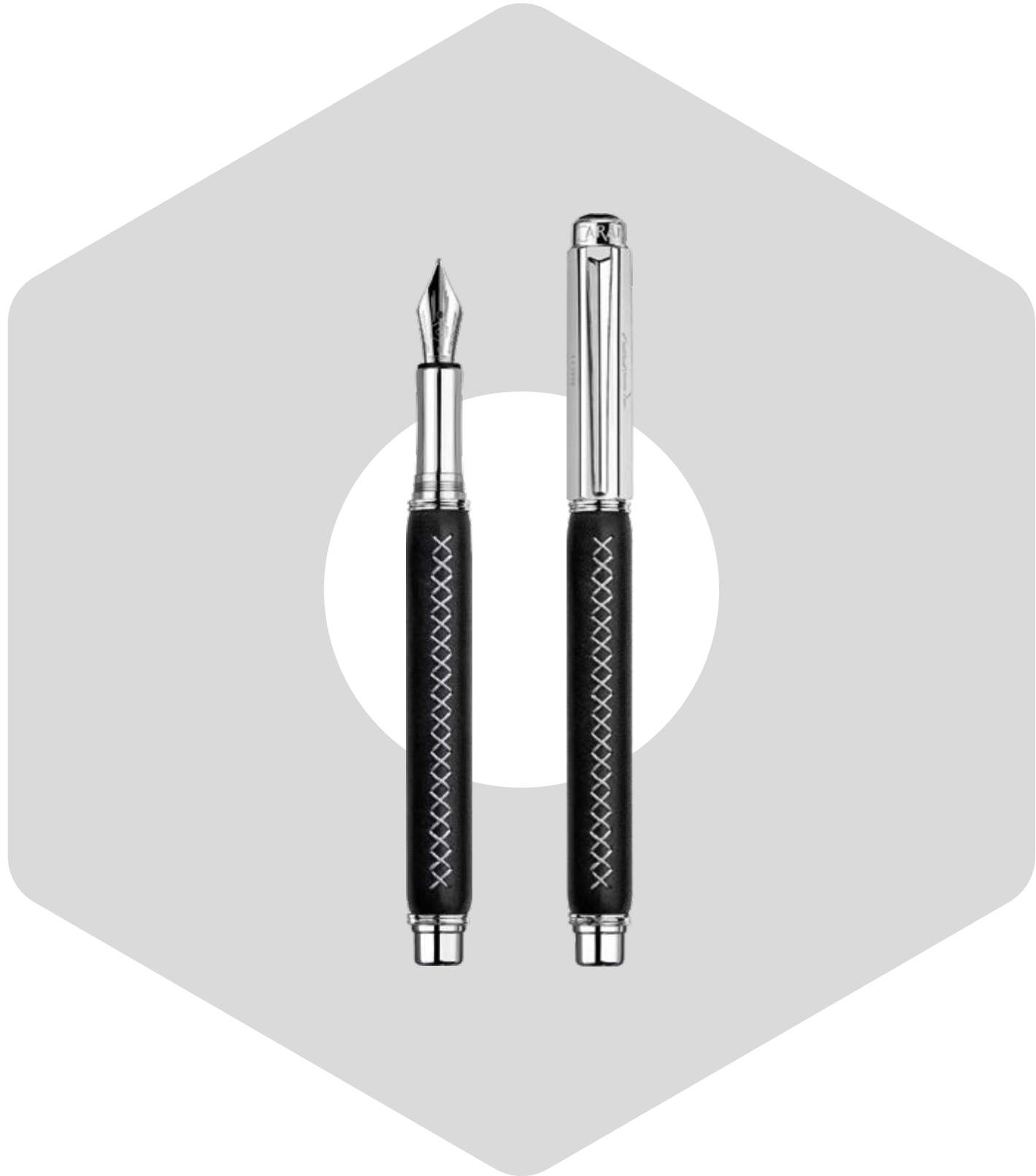

VARIUS PETER MARINO
SILVER-PLATED,
RHODIUM-COATED FINISH

FOUNTAIN PEN / M - 1652.491 (other nib widths available on request)

Nib: 18-carat gold, rhodium-coated
Refills: Ink and cartridges Chromatics Collection (p.136-141)



VARIUS PETER MARINO
SILVER-PLATED,
RHODIUM-COATED FINISH

ROLLER PEN / 1652.471

Refills: Rollerball fine tip, Fineliner fine or medium tip blue or black (p.142)



VARIUS PETER MARINO
SILVER-PLATED,
RHODIUM-COATED FINISH

BALLPOINT PEN / 1652.481

Goliath refills: large, medium or fine (p.142)



THE CASE
VARIUS PETER MARINO

19.5 x 10.2 x 6.8 cm
Made using wood entirely sheathed in imitation leather and fine black stitching. The whole is screen-printed.
The inner wedge is reversible and can house 1 or 2 pens
The Peter Marino Varius edition is delivered with: :
- its user guide / warranty
- two blue ink cartridges or one black Rollerball fine tip cartridge
- the edition brochure



THE BROCHURE
VARIUS PETER MARINO

9.5 x 19 cm
16 interior pages
Bilingual brochure: FR / EN
Available in digital version only

The specially created Varius Peter Marino limited edition is entirely in tune with the spirit of this man with a resolutely modern personality. The body of these Haute Ecriture instruments is clothed in leather, carefully crafted to ensure unprecedented comfort. Like a nod to the world of fashion dear to Peter Marino's heart, a slim grey seam adorns the entire length of the instrument. A unique engraved limited edition number pays tribute to the date he set up his first New York studio: 1/1978 (one out of 1,978). The generic numbering is engraved on the cap at a scale of 1/1978 along with Peter Marino's handwritten signature.





PRESTIGE

LIMITED EDITIONS





1010 TIMEKEEPER

With the 1010 Timekeeper limited edition, Caran d'Ache has achieved a true technical exploit celebrating the encounter between Haute Écriture and Fine Watchmaking. Two art forms inextricably linked with Swiss heritage, embodying timeless ingenuity and technical virtuosity. Essential values handed down from generation to generation.

For this limited edition, Caran d'Ache pays homage to watch dials - repositories of the identity of exceptional timepieces. Guardians of the march of time, they faithfully accompany it down through the ages. The Maison Caran d'Ache has transposed the aesthetics of watchmaking culture in the discreet design of this unique writing instrument.

10 hours and 10 minutes: the ideal moment to stop the movement of the hands. Because the 1010 Timekeeper limited edition only reveals itself to those who can freeze time and make it all their own. A timeless, high – precision piece which gradually reveals itself. Caran d'Ache has reinterpreted the constituent elements of a watch dial on an original writing instrument. A journey around the dial, instantly plunging you into the world of Fine Watchmaking.

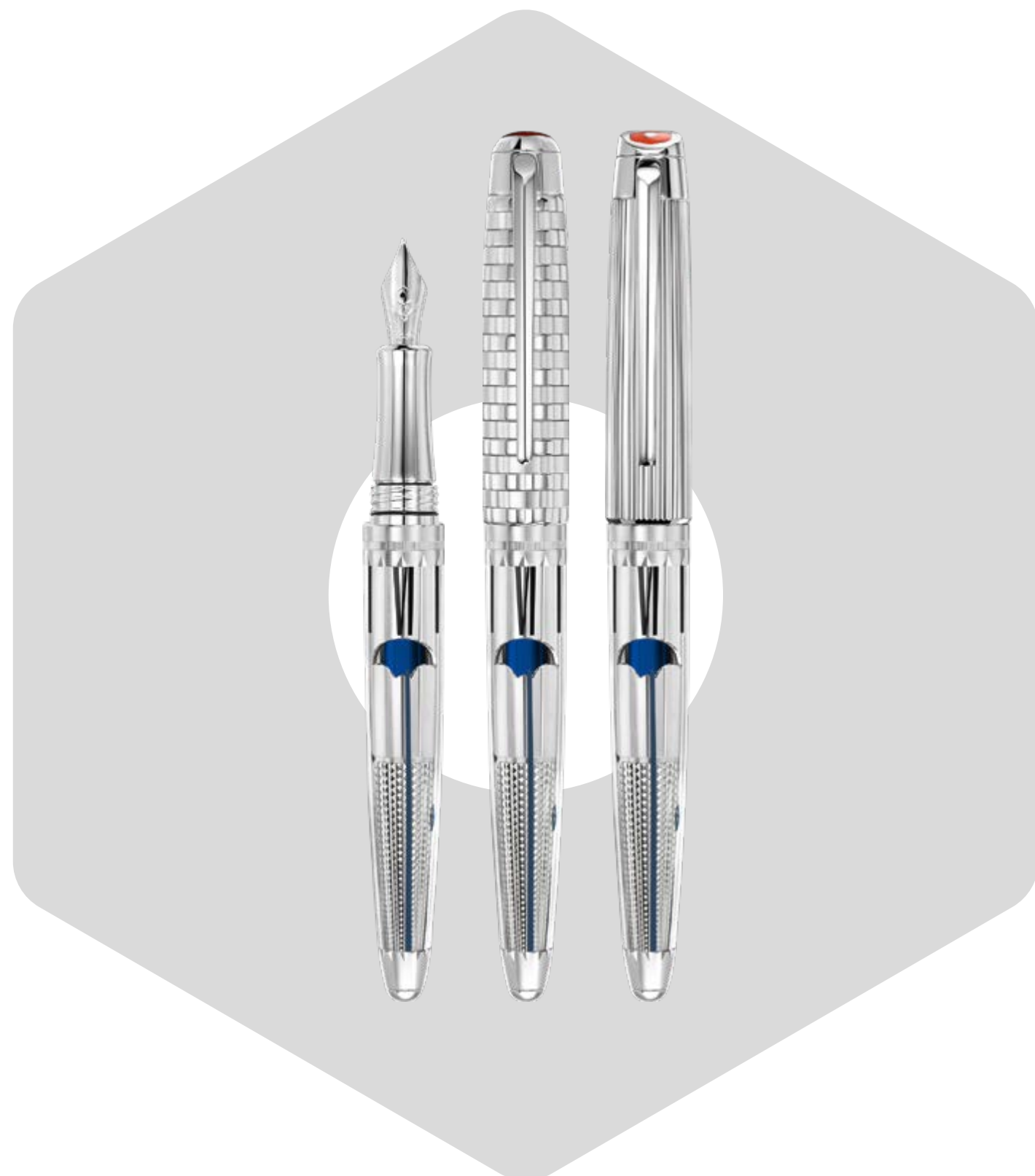

WHEN MECHANICAL ART MEETS TECHNICAL DESIGN

The 1010 Timekeeper limited edition displays its technical dimension on the silver and rhodium-plated body of the 500 pieces carefully crafted by Caran d'Ache artisans. Several elements of exclusive know - how are brought together in perfect harmony in this unique piece: guillochage, engraving, manual polishing, lacquering and PVD treatment. The 1010 Timekeeper limited edition boasts two silver and rhodium-plated caps that can be changed according to the user's desire, just as you would change a watch strap. The first cap is inspired by the mesh design of metallic watch straps. The second cap echoes the codes of watch crowns used to set the time. Both caps are engraved with a generic numbering "1 in 500 pieces".



1010 TIMEKEEPER
SILVER-PLATED,
RHODIUM-COATED FINISH

FOUNTAIN PEN / M - 1621.481 (other nib widths available on request)

Nib: 18-carat gold, rhodium-coated
Aperture inspired by the moon phases, which lets the level of ink appear in the piston pump
Refills: Chromatics Collection ink and cartridges (p.136-141)



1010 TIMEKEEPER
SILVER-PLATED,
RHODIUM-COATED FINISH

ROLLER PEN / 1622.481

Refills: Rollerball fineliner fine tip or medium tip, blue or black (p.142)

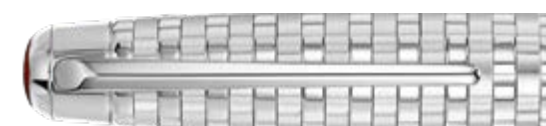

CAP – MESH EFFECT
1010 TIMEKEEPER

Mesh effect, silver-plated and rhodium-coated
Clip inspired by the design of the "Dauphine" hands
Generic numbering "1 in 500 pieces" engraved on the cap



CAP – CROWN EFFECT
1010 TIMEKEEPER

Crown effect, silver-plated and rhodium-coated
Clip inspired by the design of the "Dauphine" hands
Generic numbering "1 in 500 pieces" engraved on the cap





A black lacquered box, similar to that of a watch case, protects the 1010 Timekeeper limited edition against the signs of time. Inside, the timeless writing instrument is presented with its two caps to be interchanged without moderation.

- DELIVERED WITH THE 1010 TIMEKEEPER LIMITED EDITION:**
- two interchangeable caps
 - Idyllic Blue erasable exclusive color inkwell, finely decorated with a dial pattern
 - the edition brochure

Dimensions : 20.7 x 20.7 x 12 cm

PRESTIGE - LIMITED EDITIONS - 1010 TIMEKEEPER



THE INKWELL
1010 TIMEKEEPER

Within the box, an inkwell specially designed for this limited edition boasts a silver and rhodium-plated cover, grooved like a watch crown and finely decorated with the Caran d'Ache logo, Roman numerals and watch hands, a series of details recalling genuine watch dials.



THE BROCHURE
1010 TIMEKEEPER

21 x 21 cm
20 interior pages
Trilingual brochure: FR / DE / EN
Available in digital version only





CAELOGRAPH

Caran d'Ache unveils a unique Fine Writing instrument, the Caelograph, which combines technical expertise with design in exploring one of man's most fascinating passions: the sky. In its long tradition of innovation, Caran d'Ache has developed another exceptional writing instrument that demonstrates great creativity and expertise. Like inventors always searching for new solutions, the craftsmen at Caran d'Ache have worked closely with an astronomer to produce this unique instrument that explores the sky and the stars.

A personalised journey deep into the cosmos

Is it a writing instrument? A sky-watching tool? A work of art? The Caelograph is all of these. With a name that literally means "Write the sky" its ingenious mechanism allows you to see the position of the stars and the constellations at any given time, on any date. It brings alive the close, mystical relationship that has existed between man and the stars, Earth and sky, since the dawn of time.



As an instrument for writing and for observation, the Caelograph symbolises the union of arts and science, of the human being and the stars. Produced in three limited series, it is a compelling tribute to astronomy. The Caelograph features a sky chart that is delicately engraved on a night blue Chinese lacquer impregnated with silver particles. The grooves on the cap and the writing block are the hour lines typically found on sun dials. The pen's tip is embellished with a compass rose while the clip takes the form of a compass needle, evoking the ageless link between navigation and astronomy.



CAELOGRAPH SIRIUS
GOLD-PLATED FINISH

FOUNTAIN PEN / Latitude 20: 1632.681 / 30: 1632.581

M nib: 18-carat yellow gold (other nib widths available on request)
1 diamond on the Sirius star
Refills: Ink and cartridges Chromatics Collection (p.136-141)



CAELOGRAPH SIRIUS
GOLD-PLATED FINISH

ROLLER PEN / Latitude 45: 1642.481 / 30: 1642.581

Refills: Rollerball fine tip, Fineliner fine or medium tip blue or black (p.142)

THE MECHANICS OF THE SKY IN YOUR HAND

With great technical expertise, this exclusive invention presents a map of the sky in a design enhanced by a midnight blue Chinese lacquer. Apart from the natural requirement for accuracy, reproducing a flat map on the curved surface of a pen is a significant technical challenge. For the first time, the projection process known as Mercator has been applied to a writing instrument. In a second technical feat, Caran d'Ache has managed to represent, on a surface as small as the pen body, the 51 constellations and 353 stars visible from the northern hemisphere. And that is not all it does. The sky chart is mobile in order to indicate the position of the stars at any chosen time. This astonishing capability is made possible by an exclusive, highly ingenious mechanism based on two rings. One of the rings is mobile and is dedicated to the time, while the fixed ring is marked in days and months. By adjusting their position, the map can be set to the precise time and date required. A rotating semi-transparent sleeve reveals the visible part of the sky, indicates the horizon line, the compass points and the zenith.





The Caeograph case welcomes the new invention.
 Made of wood, gloss grey lacquered and screen printed. 3 removable wedges allowing each of these elements constituting the gift set to be positioned.

DELIVERED WITH THE CAEOGRAPH LIMITED EDITION:

- owner's guide book and warranty
- two small ink cartridges or one black Rollerball fine tip cartridge
- a Caeograph leather pouch and a Caeograph brochure

Dimensions: 26.3 x 19.3 x 10 cm



THE INKWELL
 CAEOGRAPH

The Caeograph is accompanied by a personalised ink bottle, with a stopper produced in the same finish as the instrument. Depending on the model: palladium, golden 2N or golden 5N finish. The ink is "Blue Night" colour.

THE COMPASS ROSE
 CAEOGRAPH

For at least 2000 years, the compass has been used to indicate the magnetic north. By orienting the pen accurately, it makes the Caeograph easy to use. This indispensable instrument of navigation accompanies the Caeograph in reading the sky.
 Depending on the model: palladium, golden 2N or golden 5N finish. It matches the finishing available on the writing instrument.



THE BROCHURE
 CAEOGRAPH

26 x 24 cm
 22 interior pages
 Brochure available in 5 languages:
 FR, EN, DE, CN, ES
 Available in digital version only





WRITING ACCESSORIES



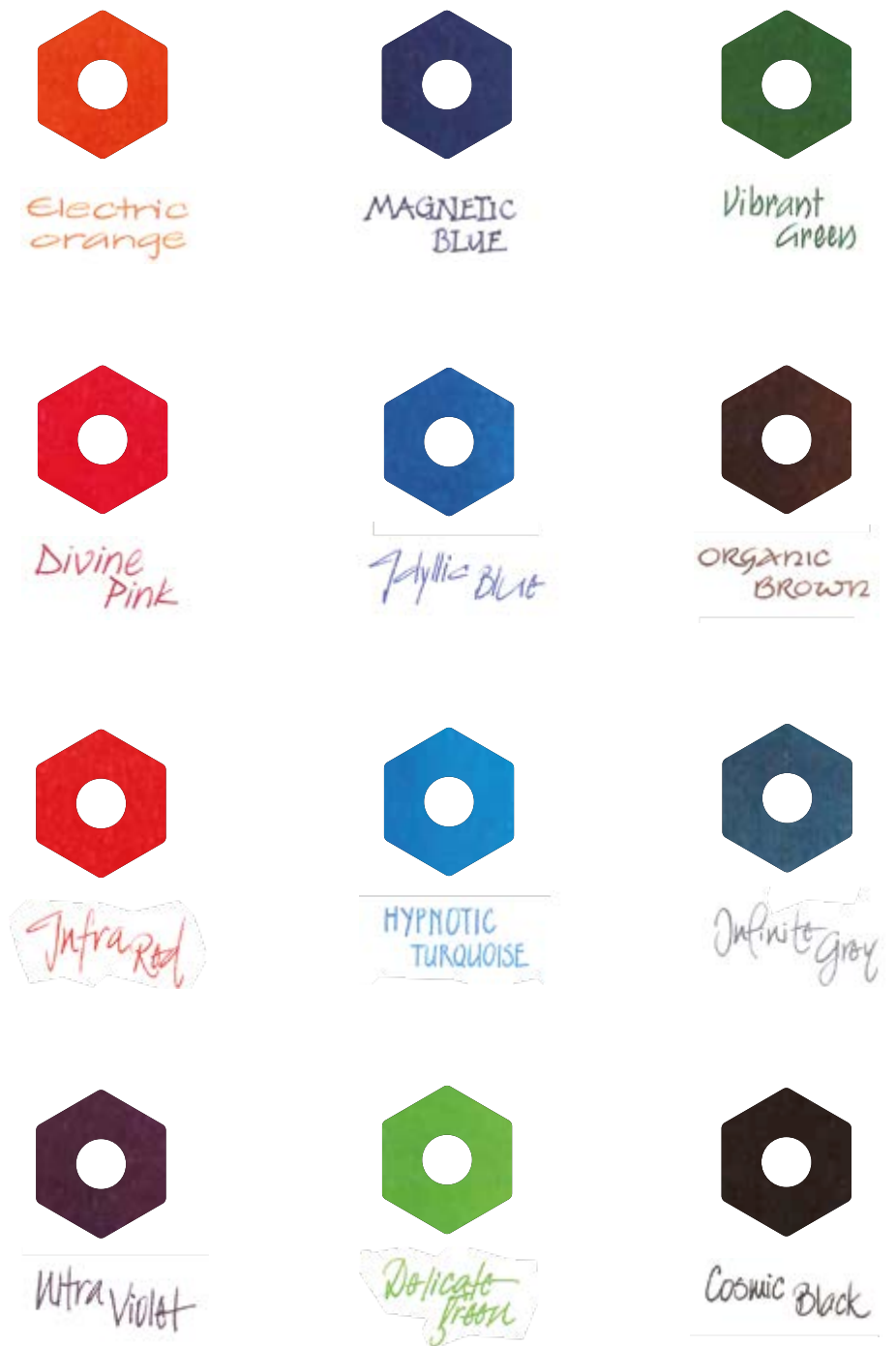

CHROMATICS

Within each new Caran d'Ache ink lies the expertise of a unique savoir-faire: the science of colours. Vibrant. Deep. Powerful. Sustained. From a bursting red to a radiant purple, from an empyreal turquoise to a fiery orange, Chromatics INKredible Colors impose their noble marks across the entire spectrum of light. Every inkwell is a prism, playing with the reflections of the light and intensifying the colour that it holds inside. Each personality submits to the caprices of evocative names that entice one inescapably away to voyage and discovery. Beyond their colours, the characters assert themselves through to the tip of the pen, and breathe life into the very page. The Art of Fine Penmanship is adorned in a colourful finery that vivifies the most beautiful pieces of written work.

12 colours / 50 ml ink bottle, with a hexagonal cap and inkwell / Ink bottle also available in sets of 6 or 12 colours / International ink cartridges (6 pieces per pack)





INK BOTTLE: ELECTRIC ORANGE / 8011.052



INK BOTTLE: DIVINE PINK / 8011.080



INK BOTTLE: HYPNOTIC TURQUOISE / 8011.191



INK BOTTLE: DELICATE GREEN / 8011.221



INK BOTTLE: INFRA RED / 8011.070



INK BOTTLE: ULTRA VIOLET / 8011.099



INK BOTTLE: VIBRANT GREEN / 8011.210



INK BOTTLE: ORGANIC BROWN / 8011.049



INK BOTTLE: IDYLIC BLUE / 8011.140



INK BOTTLE: MAGNETIC BLUE / 8011.149



INK BOTTLE: INFINITE GREY / 8011.005



INK BOTTLE: COSMIC BLACK / 8011.009





INK CARTRIDGES ELECTRIC ORANGE / 8021.052



INK CARTRIDGES DIVINE PINK / 8021.080



INK CARTRIDGES HYPNOTIC TURQUOISE / 8021.191



INK CARTRIDGES DELICATE GREEN / 8021.221



INK CARTRIDGES INFRA RED / 8021.070



INK CARTRIDGES ULTRA VIOLET / 8021.099



INK CARTRIDGES VIBRANT GREEN / 8021.210



INK CARTRIDGES ORGANIC BROWN / 8021.049



INK CARTRIDGES IDYLIC BLUE / 8021.140



INK CARTRIDGES MAGNETIC BLUE / 8021.149



INK CARTRIDGES INFINITE GREY / 8021.005



INK CARTRIDGES COSMIC BLACK / 8021.009





REFILL
ROLLERBALL PEN

ROLLERBALL, FINE TIP REFILL
8222.160 (blue) / 8228.009 (black)



REFILL
ROLLERBALL PEN

FINELINER, FINE TIP REFILL
8122.000 (blue) / 8128.000 (black)



REFILL
ROLLERBALL PEN

FINELINER, MEDIUM TIP REFILL
8122.160 (blue) / 8128.009 (black)



REFILL
BALLPOINT PEN

GOLIATH REFILL
Large 8422.260 (blue) / 8428.109 (black)
Medium 8422.000 (blue) / 8428.000 (black) / 8420.000 (red) / 8418.000 (green) / 8421.111 (violet) / 8421.191 (turquoise)
Fine 8422.160 (blue) / 8428.009 (black) / 8420.070 (red)



REFILL
BALLPOINT PEN

BI-FONCTION / XS REFILL
6522.100 (blue) / 6528.100 (black)



REFILLS
GRAPHITE LEADS

GRAPHITE LEADS 0.5 MM / 12-piece pack
6705.350 60 mm HB
6705.351 60 mm B

GRAPHITE LEADS 0.7 MM / 12-piece pack
6707.350 60 mm HB
6707.351 60 mm B



ERASERS

BLACK ERASERS
180.000



ERASERS

SPARE ERASERS
505.000 Madison, Ecridor, RNX.316
506.000 Léman
512.000 Léman Slim
513.000 Léman Bi-fonction
507.000 Varius, Ecridor XS



SHARPENING MACHINE
METAL



RED METAL SHARPENING MACHINE / 455.270
GREY METAL SHARPENING MACHINE / 455.200



ACCESSORIES





LA COLLECTION DE LA MAISON

To create its latest collection of leather goods, Caran d'Ache has combined its know-how with the talent of Isaac Reina, the internationally renowned designer famous for his modern and distinguished style. Adopting an approach inspired by industrial architecture and aesthetics, this intuitive creator has subtly revisited the codes of the Geneva-based company to create a collection boasting a highly contemporary and minimalist style. "La Collection de la Maison" includes accessories and luggage, which reflect a chic and relaxed lifestyle.

Dreamed up in the designer's Parisian workshops, this new range is made from smooth and supple leather in the pure tradition of ancestral know-how.



THE SPIRIT OF THE WRITING INSTRUMENT

LA COLLECTION DE LA MAISON



LA COLLECTION DE LA MAISON
CALFSKIN LEATHER

BLACK LEATHER CASE FOR 1 PEN / 6801.009

Synthetic leather lining
Dimensions: 16 x 3.3 cm



LA COLLECTION DE LA MAISON
CALFSKIN LEATHER

BEIGE LEATHER CASE FOR 1 PEN / 6801.055

Synthetic leather lining
Dimensions: 16 x 3.3 cm



LA COLLECTION DE LA MAISON
CALFSKIN LEATHER

MIDNIGHT BLUE LEATHER CASE FOR 1 PEN / 6801.549

Synthetic leather lining
Dimensions: 16 x 3.3 cm



LA COLLECTION DE LA MAISON
CALFSKIN LEATHER

BLACK LEATHER CASE FOR 2 PENS / 6802.009

Synthetic leather lining
Dimensions: 16 x 5.5 cm



LA COLLECTION DE LA MAISON
CALFSKIN LEATHER

BEIGE LEATHER CASE FOR 2 PENS / 6802.055

Synthetic leather lining
Dimensions: 16 x 5.5 cm



LA COLLECTION DE LA MAISON
CALFSKIN LEATHER

MIDNIGHT BLUE LEATHER CASE FOR 2 PENS / 6802.549

Synthetic leather lining
Dimensions: 16 x 5.5 cm

SPIRIT OF EXCELLENCE

All the leather collections of the Maison are made in the fine tradition of luxury leatherwork. A European high-quality calfskin has been used to manufacture the Caran d'Ache accessories. The traditional tanning processes make the leather soft to the touch, bright and naturally smooth. Leather is a living material; its appearance can differ according to the veins and colour nuances and it acquires a patina over time. The surface of the brass metal parts receives a protective coating.

Designed in Isaac Reina's workshops in France / The selected leather is a European high-quality calfskin leather with mineral tanning from Italy / All metallic parts are made in Italy



THE SPIRIT OF THE WRITING INSTRUMENT

LA COLLECTION DE LA MAISON



LA COLLECTION DE LA MAISON
CALFSKIN LEATHER

ZIPPED BLACK CASE FOR 1 PEN / 6803.009

Cotton lining
Dimensions: 20.5 x 8 cm



LA COLLECTION DE LA MAISON
CALFSKIN LEATHER

ZIPPED BEIGE CASE FOR 1 PEN / 6803.055

Cotton lining
Dimensions: 20.5 x 8 cm

LA COLLECTION DE LA MAISON
CALFSKIN LEATHER

ZIPPED MIDNIGHT BLUE CASE FOR 1 PEN / 6803.549

Cotton lining
Dimensions: 20.5 x 8 cm



THE "SIGNATURE" DETAILS OF THE COLLECTION

The natural appearance of smooth calfskin leather in 3 colours – black, midnight blue and beige – is a pleasure to be seen. Its suppleness and mineral tanning make it soft and pleasant to the touch. Each item is punched with a mark, a tip of the hat to the workers who stamp the pencils produced by the Geneva-based company. The hexagon, a key symbol of Caran d'Ache, is a simple sign identifying all the finishes in this leather goods collection. Red stitching is a subtle reminder of the original Caran d'Ache colour on all accessories and luggage.

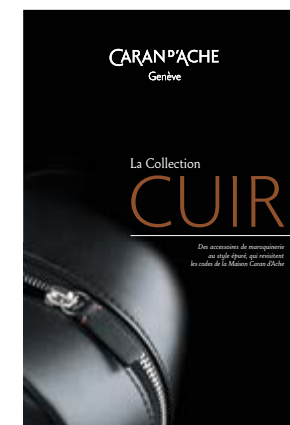

THE BROCHURE
LA COLLECTION CUIR

14.8 x 21 cm
Brochure available in 3 languages
(FR, EN, DE)
Available in digital
version only



THE SPIRIT OF WRITING LA COLLECTION DE LA MAISON



LA COLLECTION DE LA MAISON

A5 NOTE PAPER REFILL / 5533.074 - 5533.075

Dimensions: A5 notebook (14,8 x 21 x 1 cm)
2 versions:
- lined / 5533.074
- blank page / 5533.075



LA COLLECTION DE LA MAISON
CALFSKIN LEATHER

BLACK LEATHER A5 NOTEBOOK / 6833.009

Interior pen strap
Dimensions: A5 notebook (14,8 x 21 x 1 cm)
A5 note paper refill (2 versions)

LA COLLECTION DE LA MAISON
CALFSKIN LEATHER

BEIGE LEATHER A5 NOTEBOOK / 6833.055

Interior pen strap
Dimensions: A5 notebook (14,8 x 21 x 1 cm)
A5 note paper refill (2 versions)



LA COLLECTION DE LA MAISON
CALFSKIN LEATHER

BLACK LEATHER A4 FOLDER / 6824.009

Document case with elastic closing strap
Interior pen strap
Space for business cards
Dimensions: 24 x 32 cm

LA COLLECTION DE LA MAISON
CALFSKIN LEATHER

BEIGE LEATHER A4 FOLDER / 6824.055

Document case with elastic closing strap
Interior pen strap
Space for business cards
Dimensions: 24 x 32 cm



THE SPIRIT OF TRAVELLING

LA COLLECTION DE LA MAISON



LA COLLECTION DE LA MAISON
CALFSKIN LEATHER

BLACK LEATHER ATTACHE BAG / 6839.009

Adjustable and removable shoulder strap
Leather handles
Outer pen strap
Inner compartments lined with cotton
2nd inner leather pocket for laptop
Central zip opening along the entire length of the bag
Dimensions: 42 x 30 x 11 cm

LA COLLECTION DE LA MAISON
CALFSKIN LEATHER

BEIGE LEATHER ATTACHE BAG / 6839.055

Adjustable and removable shoulder strap
Leather handles
Outer pen strap
Inner compartments lined with cotton
2nd inner leather pocket for laptop
Central zip opening along the entire length of the bag
Dimensions: 42 x 30 x 11 cm



LA COLLECTION DE LA MAISON
CALFSKIN LEATHER

BLACK LEATHER WEEKEND TRAVEL BAG / 6842.009

Adjustable and removable leather shoulder strap
Leather handles
Interior compartments lined with cotton
2nd inner leather pocket for laptop
Central zip opening along the entire length of the bag
Dimensions: 50 x 28 x 21 cm

LA COLLECTION DE LA MAISON
CALFSKIN LEATHER

BEIGE LEATHER WEEKEND TRAVEL BAG / 6842.055

Adjustable and removable leather shoulder strap
Leather handles
Interior compartments lined with cotton
2nd inner leather pocket for laptop
Central zip opening along the entire length of the bag
Dimensions: 50 x 28 x 21 cm





LÉMAN BLACK
GRAINED CALFSKIN LEATHER

HOLDER FOR 1 PEN / 6201.782

Dimensions: 2.5 x 15 cm



LÉMAN WHITE
GRAINED CALFSKIN LEATHER

HOLDER FOR 1 PEN / 6201.001

Dimensions: 2.5 x 15 cm



LÉMAN RED
GRAINED CALFSKIN LEATHER

HOLDER FOR 1 PEN / 6201.770

Dimensions: 2.5 x 15 cm



LÉMAN BLUE
GRAINED CALFSKIN LEATHER

HOLDER FOR 1 PEN / 6201.449

Dimensions: 2.5 x 15 cm

LA COLLECTION LÉMAN

Vivid leather colours, deep intense shades... A fresh wind blows on Caran d'Ache accessories with this line of small leatherware that matches the writing instruments. Pen cases, card holders, and wallets in grained calfskin reject all trace of austerity. In a rainbow of colours, the Léman range gives the leather a contemporary feel, full of charm and joyful elegance.

Grained calfskin leather / Saddle stitching / Jacquard lining / Palladium-coated metal parts / One-year international warranty from the date of purchase / Manufactured in Europe





LÉMAN BLACK
GRAINED CALFSKIN LEATHER

HOLDER FOR 2 PENS / 6202.782

Dimensions: 4 x 15 cm

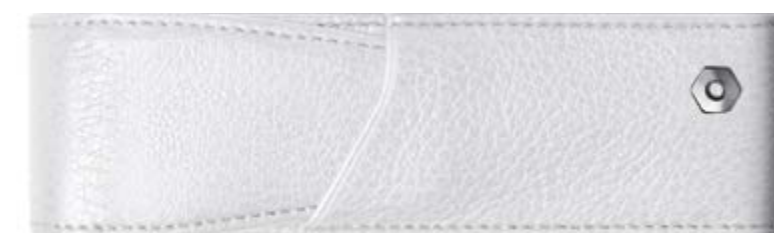

LÉMAN WHITE
GRAINED CALFSKIN LEATHER

HOLDER FOR 2 PENS / 6202.001

Dimensions: 4 x 15 cm



LÉMAN RED
GRAINED CALFSKIN LEATHER

HOLDER FOR 2 PENS / 6202.770

Dimensions: 4 x 15 cm



LÉMAN BLUE
GRAINED CALFSKIN LEATHER

HOLDER FOR 2 PENS / 6202.449

Dimensions: 4 x 15 cm





LÉMAN WHITE
GRAINED CALFSKIN LEATHER

BUSINESS CARD HOLDER / 6207.001
Dimensions: 10,5 x 8 cm



LÉMAN GREY
GRAINED CALFSKIN LEATHER

BUSINESS CARD HOLDER / 6207.007
Dimensions: 10,5 x 8 cm

LÉMAN CASHMERE
GRAINED CALFSKIN LEATHER

BUSINESS CARD HOLDER / 6207.403
Dimensions: 10,5 x 8 cm



LÉMAN SAFFRON
GRAINED CALFSKIN LEATHER

BUSINESS CARD HOLDER / 6207.530
Dimensions: 10,5 x 8 cm



KEY RING WHITE / 6239.001
Material: grained calfskin leather



KEY RING CASHMERE / 6239.403
Material: grained calfskin leather



KEY RING SAFFRON / 6239.530
Material: grained calfskin leather





A5 BOOK WHITE / 6233.001
 Material: grained calfskin leather
 Dimensions: 22x17.5 cm
 Refill: 5533.073

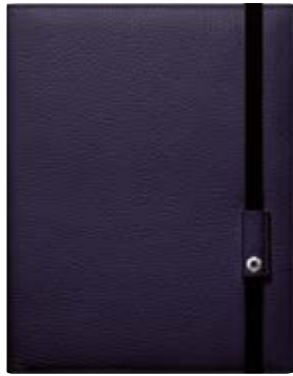

A5 BOOK BLUE / 6233.449
 Material: grained calfskin leather
 Dimensions: 22x17.5 cm
 Refill: 5533.073



A5 BOOK GREY / 6233.007
 Material: grained calfskin leather
 Dimensions: 22x17.5 cm
 Refill: 5533.073



A5 BOOK RED / 6233.770
 Material: grained calfskin leather
 Dimensions: 22x17.5 cm
 Refill: 5533.073

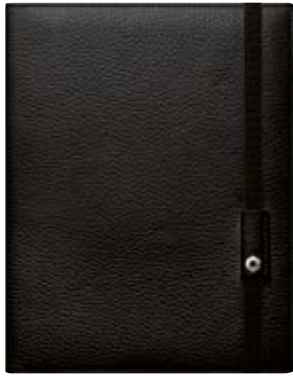

A5 BOOK BLACK / 6233.782
 Material: grained calfskin leather
 Dimensions: 22x17.5 cm
 Refill: 5533.073





BELTS CLASSIC
RECTANGULAR BUCKLE

CLASSIC REVERSIBLE BLACK / BROWN / 5205.009
Dimensions: 3 x 120 cm
Buckle: palladium-plated rectangular pin
Leather: reversible black / brown



BELTS CLASSIC
ROUND BUCKLE

CLASSIC REVERSIBLE BLACK / BROWN / 5206.009
Dimensions: 3 x 120 cm
Buckle: palladium-plated round pin
Leather: reversible black / brown

BELTS
In matters of elegance, the little details can make all the difference. Caran d'Ache appeals to seriously elegant men with a collection of reversible belts for a contemporary look. The Maison has used all its expertise to develop these top-of-the-range accessories that are made from the finest leathers and fitted with metal buckles coated in palladium.

Reversible colour belts / Length adjustable by strap cutting process / Buckle in strap-cutting, palladium-plated brass / One-year international warranty from the date of purchase / Manufactured in Italy





CUFFLINKS CHEVRON / 5350.286

Material: stainless steel



CUFFLINKS TYPE 55 / 5350.455

Material: stainless steel



CUFFLINKS ALLIGATOR / 5350.021

Body covered in chocolate brown alligator skin
Material: stainless steel



CUFFLINKS CUBRIK / 5350.377

Material: stainless steel



CUFFLINKS SNAKEWOOD / 5350.023

Snakewood body
Material: stainless steel



CUFFLINKS RETRO / 5350.485

Material: stainless steel

CUFFLINKS

Much admired by discerning clients, the Maison Caran d'Ache declares its intentions by emphasizing this accessory which is not simply a piece of jewellery but a genuine fashion accessory. The perfect harmony between writing instruments and cufflinks is an expression of ultimate refinement where no details has been left to chance. Choosing a Caran d'Ache writing instrument means choosing the signature of style and prestige. Precious and visually striking, these fashion accessories are an extension of each collection of writing instruments, imbued with the same character and originality.

Stainless steel / One-year international warranty from the date of purchase

VARIUS

Based on the design of the Varius collection, the iconic line of the Brand, the Geneva craftsmen have expanded their expertise in working with noble materials and have developed superb variations around the chain mail, snakewood and alligator leather.

ECRIDOR

The Ecridor collection explores the infinite possibilities of the famous hexagon with highly successful adaptations of the Type 55, Cubrik and Retro lines. The body of each model, produced in stainless steel, carries the Caran d'Ache signature engraved on the mechanism.





SERVICES



PERSONALISED ENGRAVING

Numerous Caran d'Ache writing instruments can be engraved on request to the Brand retailers. On the opposite side the clip, the company's craftsmen have taken care to leave a space intended for personalised engraving.

This is where the customer can give free rein to his or her imagination. A name, a date or a short message... the writing instrument becomes a highly personal object, unlike any other.

TYPEFACES OF THE MAISON CARAN D'ACHE

USUAL FONTS:

Helvetica
Book Antiqua

CURSIVE FONTS INSPIRED BY HAND WRITING:

Script Filaire
Monotype Corsiva



VARIUS:

- Engraving on the cap
- 3 typefaces available (Helvetica / Book Antiqua / Script Filaire)



LÉMAN / LÉMAN SLIM:

- Engraving on the cap in the colour of the attributes
- 3 typefaces available (Helvetica / Book Antiqua / Script Filaire)



ECRIDOR:

- Engraving on the cap
- 3 typefaces available (Helvetica / Book Antiqua / Monotype Corsiva)

Typefaces and the number of characters may vary depending on the collection.

FOUNTAIN PEN NIBS

The most authentic form of writing, showing every variation in pressure and speed, is that of the fountain pen. A pen moulds itself to its user's writing, which is why Caran d'Ache offers a range of widths for its hand-made and hand-polished nibs offering their owners exquisite writing comfort.



- Nibs made from rhodium-plated steel, 18-carat gold, rhodium-plated 18 carat gold or 18-carat pink gold-plating
- For the Ecridor, the nibs are made from rhodium- or silver-plated stainless steel
- For the Ecridor and Léman, the nibs are available in 4 tip sizes: F, M, B, BB
- For the Varius, the nibs are available in 7 tip sizes: F, M, B and EF, BB, OM, OB on request
- Unparalleled writing comfort recognised worldwide

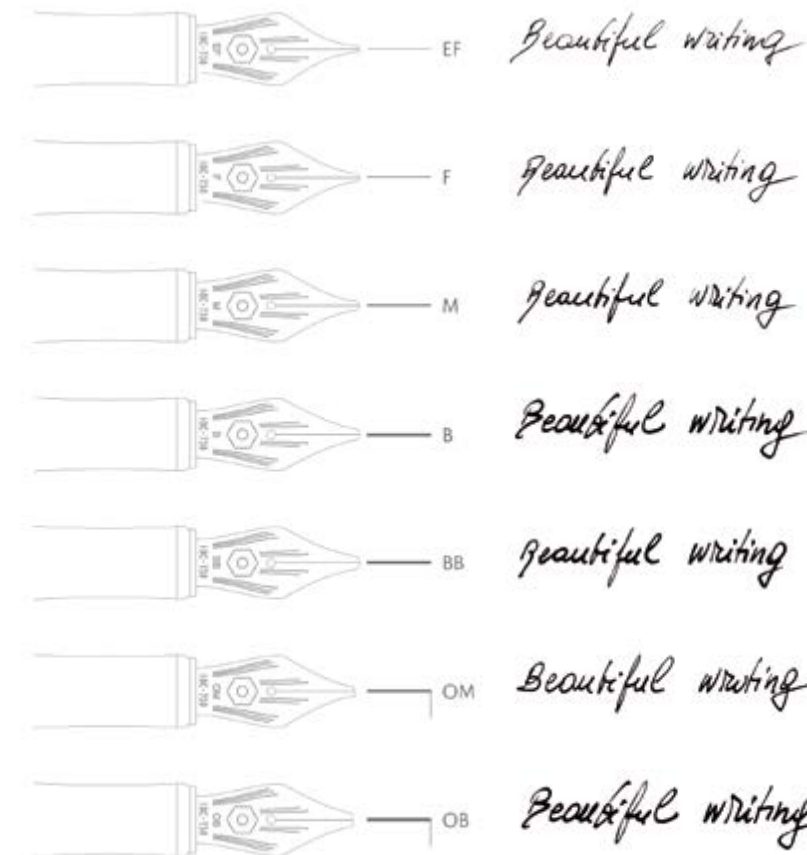

INTERNATIONAL WARRANTY

Lovers of handwriting often develop a real attachment to their pens. For this reason, our after-sales technicians do their very best to repair them whenever possible, only replacing them as a last resort. Repairs under warranty are free of charge and other repairs are only carried out after the client has accepted a cost estimate. Caran d'Ache writing instruments are inspected and tested at each stage of production. When they leave the Geneva workshops they are in perfect condition and are warrantyd against any manufacturing defects. An international warranty certificate accompanies each instrument.

HOW TO FILL IN THE WARRANTY CERTIFICATE ?

- Product: product reference
- Date of purchase: month / year
- Finishing: gold, silver, gold-plated, silver-plated, palladium-coated, platinum-coated etc.
- Dealer's stamp: from the retailer

INTERNATIONAL WARRANTY EXTENSION

Alternatively, you can scan the QR CODE to download the user manual and activate the international warranty extension.



CORPORATE GIFTS

The name itself represents a prestigious, educational world and is now a synonym for excellence and creativity. More than simply a brand, the Swiss company has imposed its own style: a "Maison de Haute Écriture". With more than 200 writing instruments for both top-of-the-range luxury market and for the office, Caran d'Ache can propose many personalised gifts which are sure to capture attention. If you wish to thank your clients and keep their loyalty, or invigorate your sales team, have a look through our special catalogue and ask us for a quotation.

PACKAGING

To meet the needs of our partners and their customers, Caran d'Ache provides easily identifiable packaging for each of our writing instruments with a consistent choice of colours, optimal sizes, designs and top-of-the-range materials. Black cases highlighted with Caran d'Ache logo in hot silver makes a high-quality presentation for all writing instruments reinforcing the Brand's image carefully preserved over several generations.

- Red shopping bags with black handles (available in 3 sizes)
- Gift pouches with adhesive closure (available in 3 sizes)
- Red or white satin ribbon with embossed logo
- Reversible red and black wrapping paper with logo



THE MERCHANDISING

Our merchandising concept for writing instruments reflects a recent realisation by the company: the opportunity to present all our products and ranges in the same place and with the same identity.

To mark its centenary in 2015, Caran d'Ache unveiled a new, single logo for all its products. This logo, (while drawing on the history of the Brand) is clear, sober and modern, offering new visibility. It is sometimes also accompanied by the hexagonal isotype, directly inspired by the iconic pencils by Caran d'Ache.

It is against this backdrop, and with a desire to juxtapose our three worlds in a coherent manner, that the global retail concept has been defined. The Haute Écriture concept is thus the fruit of this new juxtaposition and adapts to the new codes and new identification. It, too, is clear and modern.

THE MERCHANDISING CATALOGUE

The aim of this document is to incorporate all the tools and guidelines in order to ensure optimum presentation of our writing range in our corners, our furniture or in any presentation space.

Brochure available as a PDF file.



carandache.com

CARAN D'ACHE

Genève



The mark of
responsible forestry
FSC® C005365
www.fsc.org

CARAN D'ACHE S.A. – Chemin du Foron, 19 – CH-1226 Thônex-Genève

Tel. +41 (0) 22 869 01 01 – Fax +41 (0) 22 869 01 39

ECRIDOR SAS · 5, Place Porte de France · F-74240 Gaillard

This catalogue is printed
on FSCTM™ paper.

carandache.com